

Advanced Diagnostic Tools and ADT View software



This page is intentionally left blank.

Contents

1.	General information	6
1.1	Overview	6
1.2	Legal notices	7
1.3	General specifications	9
1.4	Minimum requirements	9
1.5	ADTa-100	10
1.5.1	Dimensions	10
1.5.2	Pin-out	11
1.5.3	LED indication	11
1.5.4	User button	11
1.6	ADTi-100	12
1.6.1	Dimensions	12
1.6.2	Pin-out	13
1.6.3	LED indication	13
2.	Connecting the ADT	14
2.1	General connection	14
2.2	Analogue QUANTiC connection	15
3.	Installing and connecting the ADT View software	16
3.1	Installing the software	16
3.2	Connecting to an ADT	16
3.2.1	ADT selection	17
3.2.2	ADT connection errors	18
3.2.3	Saving data	18
4.	Settings	19

4.1	Common settings19
4.2	System specific settings19
4.3	Adding, naming, and editing rings and discs (incremental only)20
4.3.1	Adding a ring or disc21
4.3.2	Editing a ring or disc21
5.	Using the ADT View software with ADTa-100.22
5.1	Overview22
5.2	Digital readout (DRO) and signal screen23
5.2.1	Signal strength24
5.2.2	Digital readout of the encoder position24
5.2.3	Set zero position function.25
5.2.4	Alarms and warnings28
5.3	Signal strength vs position screen30
5.3.1	Linear systems.30
5.3.2	Rotary systems31
5.3.3	Graph controls32
5.4	Configuration screen33
6.	Using the ADT View software with ADTi-10034
6.1	Analogue variants of QUANTiC only34
6.2	Overview35
6.3	Linear/Rotary selection36
6.4	Signal screen37
6.4.1	Signal strength38
6.4.2	Reference mark phasing38
6.4.3	Readhead mode38
6.4.4	Pitch indication.39

6.4.5	System calibration39
6.4.6	Alarms and warnings41
6.5	Lissajous (X-Y) screen43
6.6	Signal strength vs position screen44
6.6.1	Linear system.44
6.6.2	Rotary system45
6.6.3	Signal strength and IRED drive plots46
6.6.4	Graph controls47
6.7	Velocity plot49
6.7.1	Graph controls50
6.8	Digital readout (DRO).51
6.8.1	Linear system.51
6.8.2	Rotary system52
6.8.3	DRO controls53
6.9	Configuration screen54
6.9.1	Restore factory defaults55
7.	Troubleshooting56
7.1	Software installation56
7.2	System connection.56
7.3	General56
7.4	Calibration57
7.5	Signal screen57
7.6	Signal strength vs position screen58
7.7	Velocity screen.59
7.8	DRO screen59
7.9	Configuration screen59

1. General information

1.1 Overview

The optional Advanced Diagnostic Tools and ADT View software provide information to aid readhead set-up and system diagnosis.

NOTES:

- This user guide describes how to use the Advanced Diagnostic Tools and ADT View software only. For instructions on how to install and set up the encoder system, refer to the relevant system installation guide. These can be found at www.renishaw.com/encoderinstallationguides.
- Not all RESOLUTE and EVOLUTE encoders are compatible with the ADTa-100. ADTa-100 compatible readheads are marked with the symbol **ADT**.

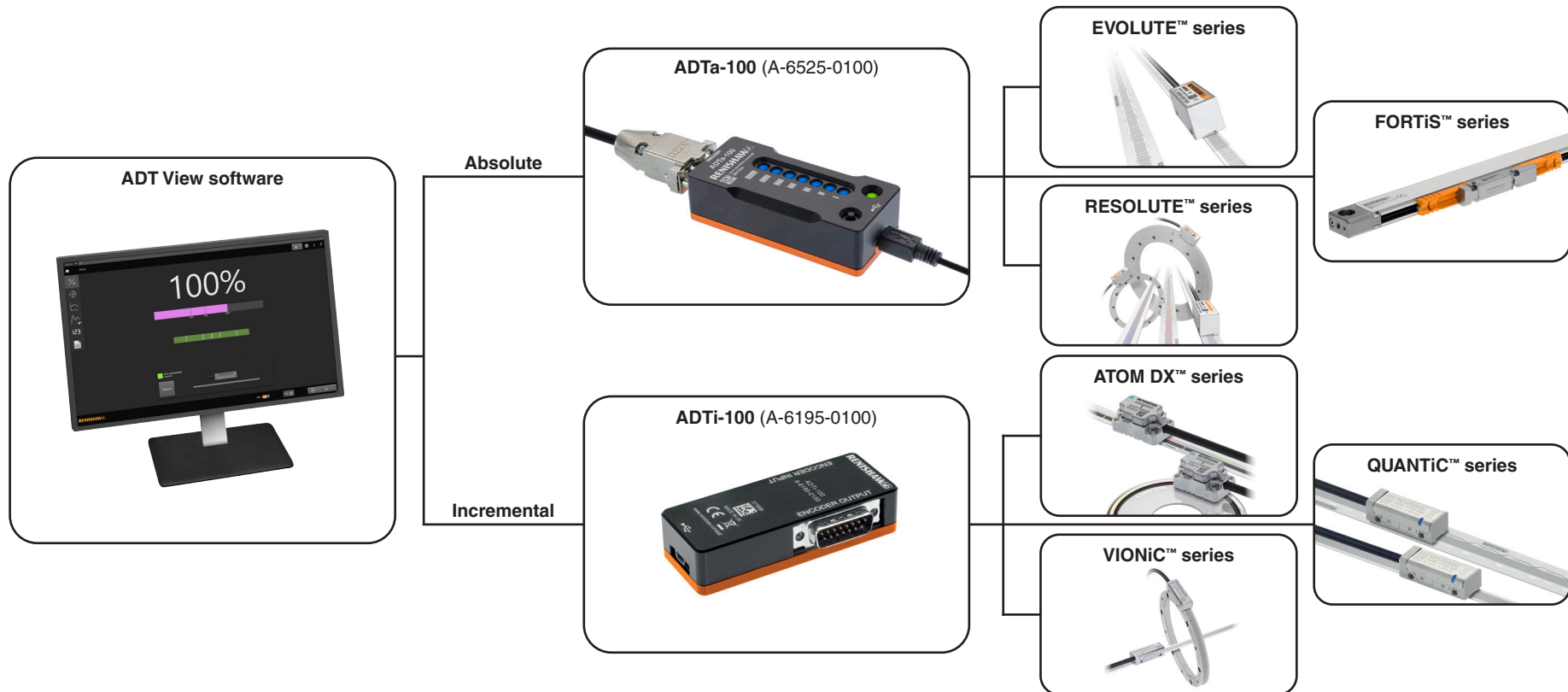

1.2 Legal notices

Terms and conditions and warranty

Unless you and Renishaw have agreed and signed a separate written agreement, the equipment and/or software are sold subject to the Renishaw Standard Terms and Conditions supplied with such equipment and/or software, or available on request from your local Renishaw office.

Renishaw warrants its equipment and software for a limited period (as set out in the Standard Terms and Conditions), provided that they are installed and used exactly as defined in associated Renishaw documentation. You should consult these Standard Terms and Conditions to find out the full details of your warranty.

Equipment and/or software purchased by you from a third-party supplier is subject to separate terms and conditions supplied with such equipment and/or software. You should contact your third-party supplier for details.

Declaration of Conformity

Renishaw plc hereby declares that the ADTa-100 and ADTi-100 are in compliance with the essential requirements and other relevant provisions of:

- the applicable EU directives
- the relevant statutory instruments under UK law



The full text of the declaration of conformity is available at: www.renishaw.com/productcompliance.

Compliance

1.2.1.1 Federal Code Of Regulation (CFR) FCC Part 15 – RADIO FREQUENCY DEVICES

47 CFR Section 15.19

This device complies with part 15 of the FCC Rules. Operation is subject to the following two conditions: (1) This device may not cause harmful interference, and (2) this device must accept any interference received, including interference that may cause undesired operation.

47 CFR Section 15.21

The user is cautioned that any changes or modifications not expressly approved by Renishaw plc or authorised representative could void the user's authority to operate the equipment.

47 CFR Section 15.105

This equipment has been tested and found to comply with the limits for a Class A digital device, pursuant to part 15 of the FCC Rules. These limits are designed to provide reasonable protection against harmful interference when the equipment is operated in a commercial environment.

This equipment generates, uses, and can radiate radio frequency energy and, if not installed and used in accordance with the instruction manual, may cause harmful interference to radio communications. Operation of this equipment in a residential area is likely to cause harmful interference in which case the user will be required to correct the interference at his own expense.

47 CFR Section 15.27

This unit was tested with shielded cables on the peripheral devices. Shielded cables must be used with the unit to ensure compliance.

Supplier's Declaration of Conformity

47 CFR § 2.1077 Compliance Information

Unique Identifier: ADTa-100 and ADTi-100

Responsible Party - U.S. Contact Information

Renishaw Inc.
1001 Wesemann Drive
West Dundee
Illinois
IL 60118
United States
Telephone number: +1 847 286 9953
Email: usa@renishaw.com

ICES-001 — Industrial, Scientific and Medical (ISM) Equipment (Canada)

This ISM device complies with CAN ICES-001 (A).

Cet appareil ISM est conforme à la norme ICES-001 (A) du Canada.

Intended use

ADTa, ADTi, and ADT View software are designed to assist installation and fault diagnosis. They must be installed, operated, and maintained as specified in Renishaw documentation and in accordance with the Standard Terms and Conditions of the Warranty and all other relevant legal requirements.

Further information

Further information relating to the encoder range and the installation of the encoder can be found in the relevant data sheets and installation guides. These can be downloaded from our website at www.renishaw.com/opticalencoders and are also available from your local Renishaw representative.

Packaging

The packaging of our products contains the following materials and can be recycled.

Packing component	Material	ISO 11469	Recycling guidance
Outer box	Cardboard	Not applicable	Recyclable
	Polypropylene	PP	Recyclable
Inserts	Low density polyethylene foam	LDPE	Recyclable
	Cardboard	Not applicable	Recyclable
Bags	High density polyethylene bag	HDPE	Recyclable
	Metallised polyethylene	PE	Recyclable

REACH regulation

Information required by Article 33(1) of Regulation (EC) No. 1907/2006 ("REACH") relating to products containing substances of very high concern (SVHCs) is available at www.renishaw.com/REACH.

Disposal of waste electrical and electronic equipment



The use of this symbol on Renishaw products and/or accompanying documentation indicates that the product should not be mixed with general household waste upon disposal. It is the responsibility of the end user to dispose of this product at a designated collection point for waste electrical and electronic equipment (WEEE) to enable reuse or recycling. Correct disposal of this product will help to save valuable resources and prevent potential negative effects on the environment. For more information, contact your local waste disposal service or Renishaw distributor.

1.3 General specifications

Power supply	5 V ±10%	The advanced diagnostic tools can be powered from the USB port or an external 5 Vdc supply with the requirements for SELV of standard IEC 60950-1
	ADTa-100	Typical current consumption < 90 mA
	ADTi-100	Typical current consumption < 20 mA
	Ripple	200mVpp maximum at frequency up to 500 KHz
Temperature	Storage	-20 °C to +70 °C
	Operating	0 °C to +55 °C
Humidity		95% relative humidity (non-condensing) to IEC 60068-2-78
Sealing		IP20
Mass	ADTa-100	155 g
	ADTi-100	110 g

1.4 Minimum requirements

- Supported Windows® operating systems (x86 or x64): 10
- Quad-core 1.44-1.92 GHz processor
- 2 GB DDR3 RAM
- 5 GB disk space (including 2.5 GB for .NET)
- 500 MHz GPU capable of 1024 x 600 resolution or higher

1.5 ADTa-100

1.5.1 Dimensions

Dimensions in mm

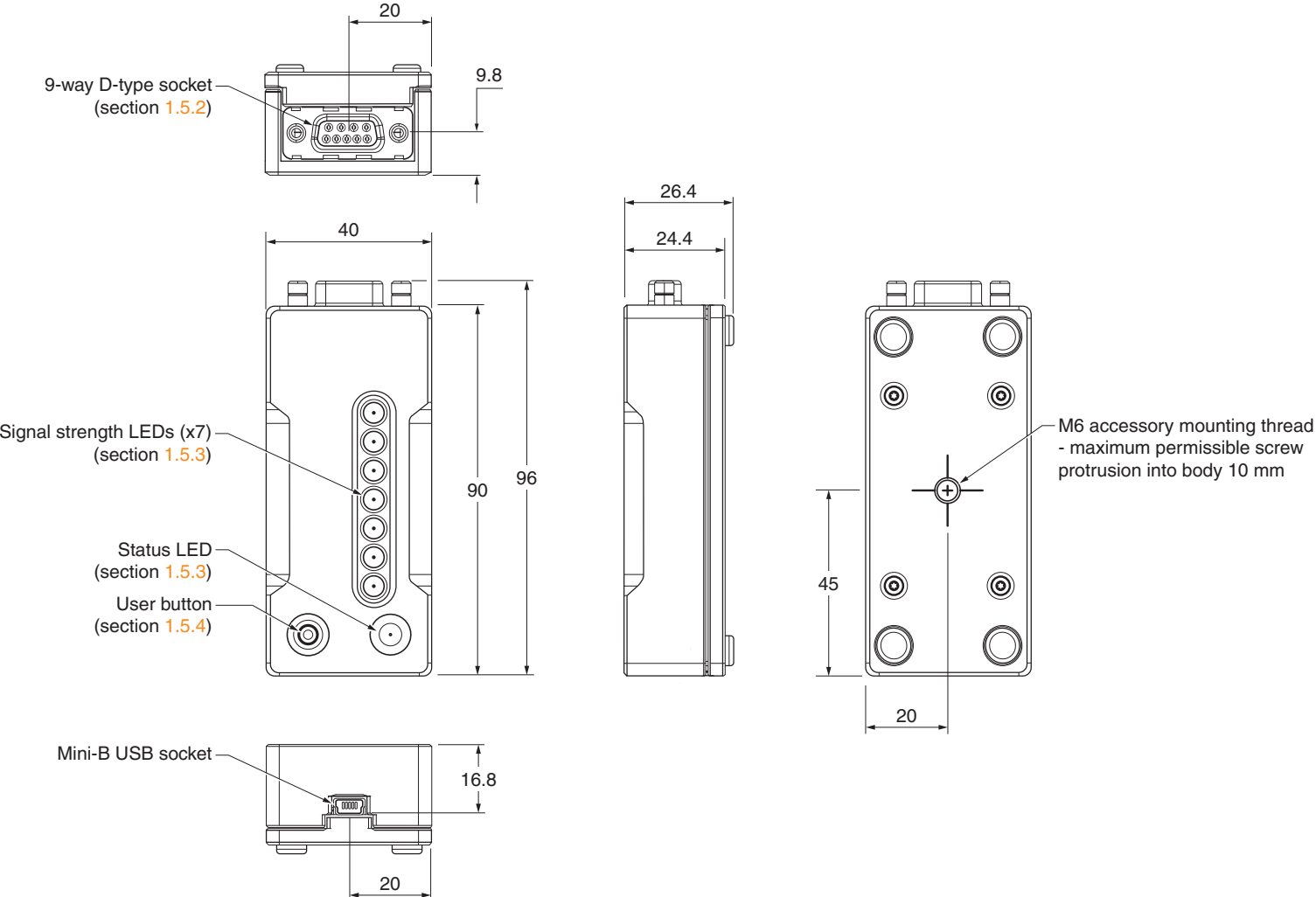

1.5.2 Pin-out

Function	Signal	Input pins (9-way D-type socket)	
Power	5 V	4, 5	
	0 V	8, 9	
Serial communications	REQ/SD	+	2
		-	3
Shield (case)	Outer	Cable screen	
Not connected	-	1, 6, 7	

1.5.3 LED indication

LED	Indication	Status
Signal strength indicator	7 blue LEDs	Excellent signal strength (RESOLUTE and FORTiS systems only)
	7 green LEDs	Excellent signal strength (EVOLUTE systems only)
	4 to 6 green LEDs	Good signal strength
	2 to 3 orange LEDs	Moderate signal strength
	1 red LED	Poor signal
	Flashing LEDs	Connected readhead is in a position error state
Status	Green LED	Connected encoder is in diagnostic mode
	Orange LED	Idle
	Red LED	Connection error

1.5.4 User button

- To use the ADTa-100 in standalone mode (section 2) briefly press the user button (~0.5 second). This will command the encoder to enter diagnostic mode.
- To clear latched errors, briefly press the user button (0.5 second). Provided the source of the error is no longer present, the flashing of the signal strength LEDs will stop and normal operation will resume.
- To turn off the connected encoder and leave diagnostic mode, press the user button (> 3 seconds).

1.6 ADTi-100

1.6.1 Dimensions

Dimensions in mm

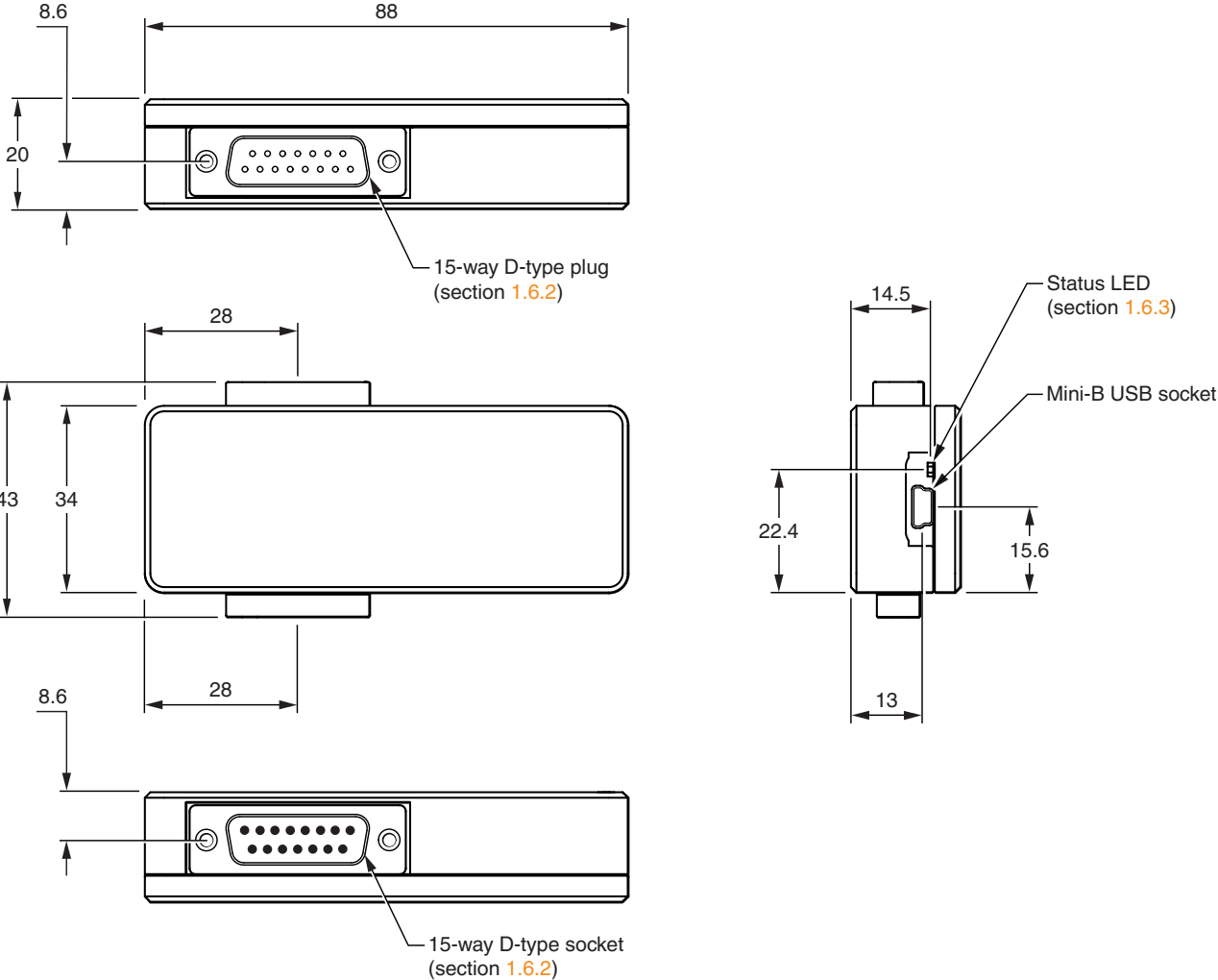

1.6.2 Pin-out

Function	Signal		Input pins (15-way D-type socket)	Output pins (15-way D-type plug)
Power	5 V		7, 8	7, 8
	0 V		2, 9	2, 9
Incremental	A	+	14	14
		-	6	6
	B	+	13	13
		-	5	5
Reference mark	Z	+	12	12
		-	4	4
Limits	P		11	11
	Q		10	10
Alarm	E	-	3	3
CAL/Comms	-		1	-
Not connected	-		15	15
Shield	-		Case	Case

NOTE: Adaptor cables required when connecting the analogue variant of QUANTiC (section 2.2).

1.6.3 LED indication

LED	Indication	Status
Status	Red LED	ADT connected to PC or controller
	Green LED	ADT View software communicating with ADT

2. Connecting the ADT

2.1 General connection

The ADT can be used in several ways:

Standalone (ADTa-100 only)

- No PC, laptop or tablet required
- The ADTa-100 is connected to the readhead and powered via the USB port from a power supply or a battery pack
- The signal size and encoder status are displayed via the built-in LED array (section 1.5.3)

Tethered

- Requires PC, laptop or tablet with ADT View software
- The ADT is connected to the readhead and powered via the PC's USB port
- The diagnostics information is displayed via the ADT View software

NOTE: When connecting the analogue variant of QUANTiC see section 2.2 for more details.

In-line (ADTi-100 only)

- Requires PC, laptop or tablet with ADT View software
- The ADTi-100 is connected between the readhead and the controller as part of the control loop
- The diagnostics information is displayed via the ADT View software

NOTES:

- When using the ADT in-line use an isolated battery-operated PC to ensure best noise immunity.
 - When connecting the analogue variant of QUANTiC see section 2.2 for more details.
-

		ADTa-100	ADTi-100
Standalone		✓	✗
ADT View software	Tethered	✓	✓
	In-line	✗	✓

The ADTa-100 has a standard 9-way D-type connector and the ADTi-100 has standard pin-out 15-way D-type connectors. For readheads with alternative pin-outs or connectors adaptor cables are required. For available adaptor cables contact your local Renishaw representative.

2.2 Analogue QUANTiC connection

The analogue variant of QUANTiC, with a standard pin-out 15-way D-type connector, has a different pin-out to the digital readheads with the same connector type, so an adaptor cable is required to connect the readhead to the ADT.

An adaptor cable kit (A-6637-1540) consisting of two 0.1 m adaptor cables, allows the readhead to be connected in either tethered or in-line mode.

Tethered

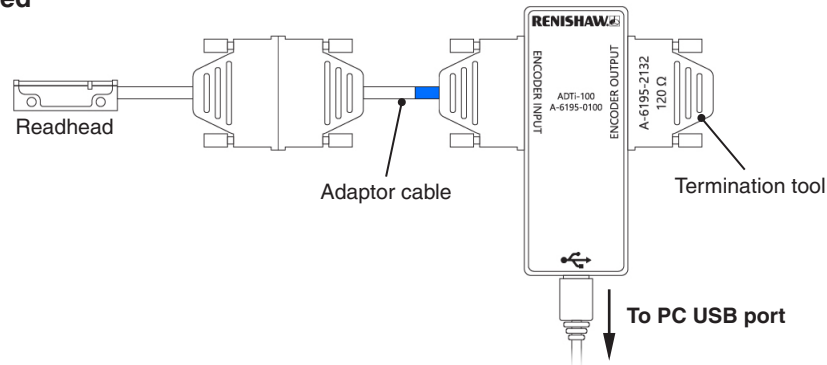

In-line

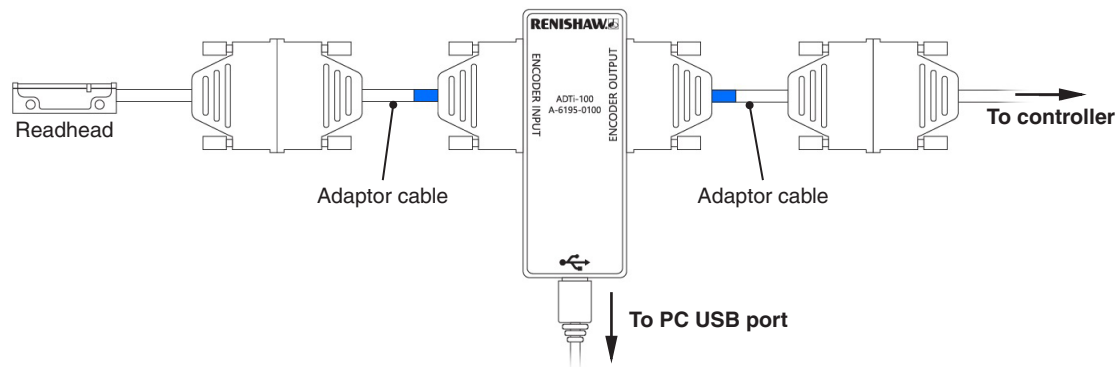

For readheads with alternative pin-outs or connectors, adaptor cables are required. For available adaptor cables contact your local Renishaw representative.

NOTE: The output of the ADTi-100 must be terminated with 120 ohms, either within the controller when in-line, or with the termination tool (A-6195-2132) when in tethered mode, for correct system function.

3. Installing and connecting the ADT View software

3.1 Installing the software

IMPORTANT: Full administration rights are necessary to install and uninstall the ADT View software.

The software is free to download from www.renishaw.com/adt. Follow the on-screen instructions to install and run the software.

3.2 Connecting to an ADT

When the ADT View software is opened it will automatically detect any connected ADTs.

If an ADTa-100 is connected the software will open the Position display (Digital readout) and signal screen (section 5.2) or, if an ADTi-100 is connected, the software will open the Signal screen (section 6.4). For QUANTiC analogue systems, a termination reminder will be displayed (section 6.1).

NOTE: If multiple ADTs are connected then a selection screen will appear allowing the user to select the ADT that is to be displayed (section 3.2.1).

If the ADT View software is opened and no ADTs are connected then the following screen will display until an ADT is connected:

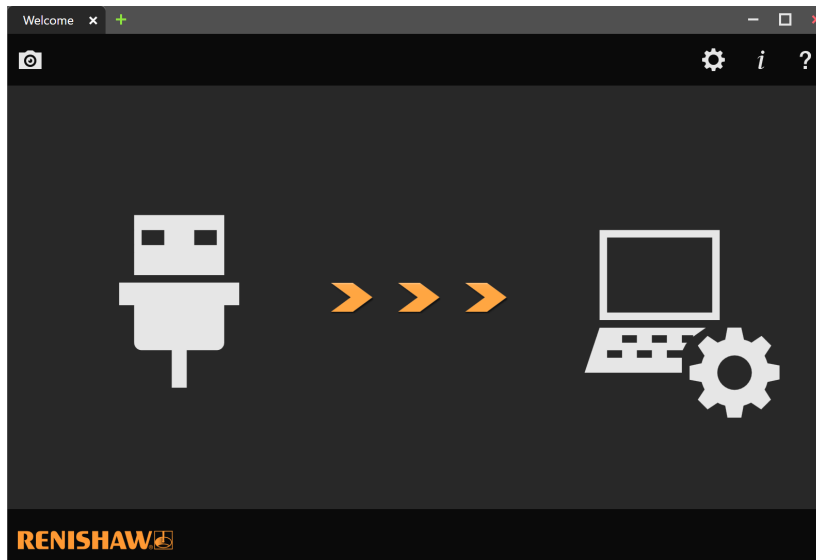

3.2.1 ADT selection

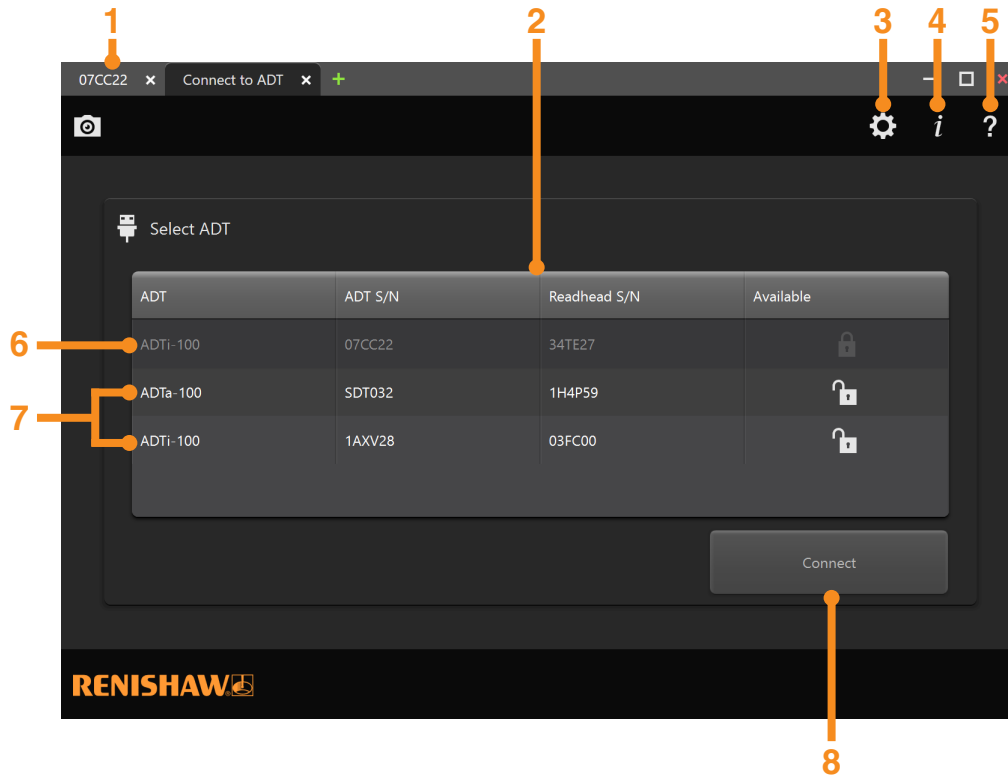

1. Tab page for connected ADT. Select to view ADT information.

NOTE: Multiple ADTs can be connected to the ADT View software.

2. ADT selection screen
3. Settings (section 4)
4. Software information
5. User guide

6. Connected ADT

NOTE: Connected ADTs will be greyed out.

7. Available ADTs. Click on the chosen ADT and then Connect.
8. Connect to selected ADT

3.2.2 ADT connection errors

If connection is lost to the selected ADT or readhead then a Connection Lost screen will be displayed. The data from the currently displayed screen can be saved where applicable.

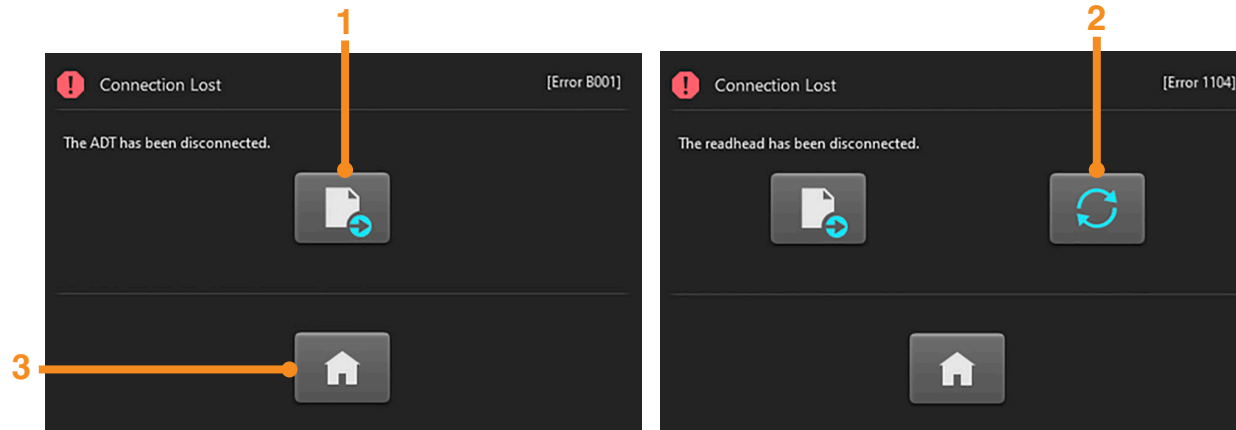

1. Save data (section 3.2.3)
2. Refresh the connection to the readhead
3. ADT selection screen

3.2.3 Saving data

The ADT information can be saved either as a screenshot or, depending on the screen, as a .csv file.



Take a screenshot.



Save data as a .csv file.

4. Settings



The settings icon opens a new tab to allow the selection of user display preferences. The common settings can be accessed without an encoder system connected. System specific settings are displayed once an encoder system is connected.

4.1 Common settings

- Display
 - Select dark or light display
 - Change language
- File export options
 - Select csv delimiter and separator
- Updates
 - Allow automatic check for new versions of ADT View
- Custom Incremental Rotary (section 4.3)
 - Add and delete rings/discs
 - Import and export the custom ring/disc file

4.2 System specific settings

ADTa-100

- Select angular/linear units
- Enable Set Zero function (section 5.2.3)

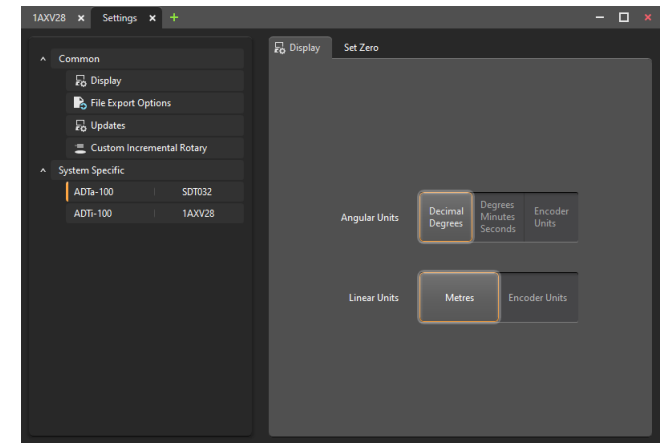

ADTi-100

- Select angular units

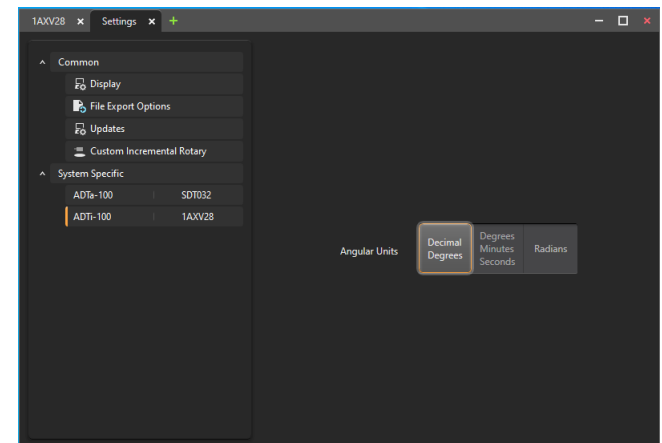

4.3 Adding, naming, and editing rings and discs (incremental only)

Custom incremental rings and discs can be added, named, and the information saved to a file or imported.

NOTE: The standard rotary scales are already included in the rotary selection menu (section 6.3).

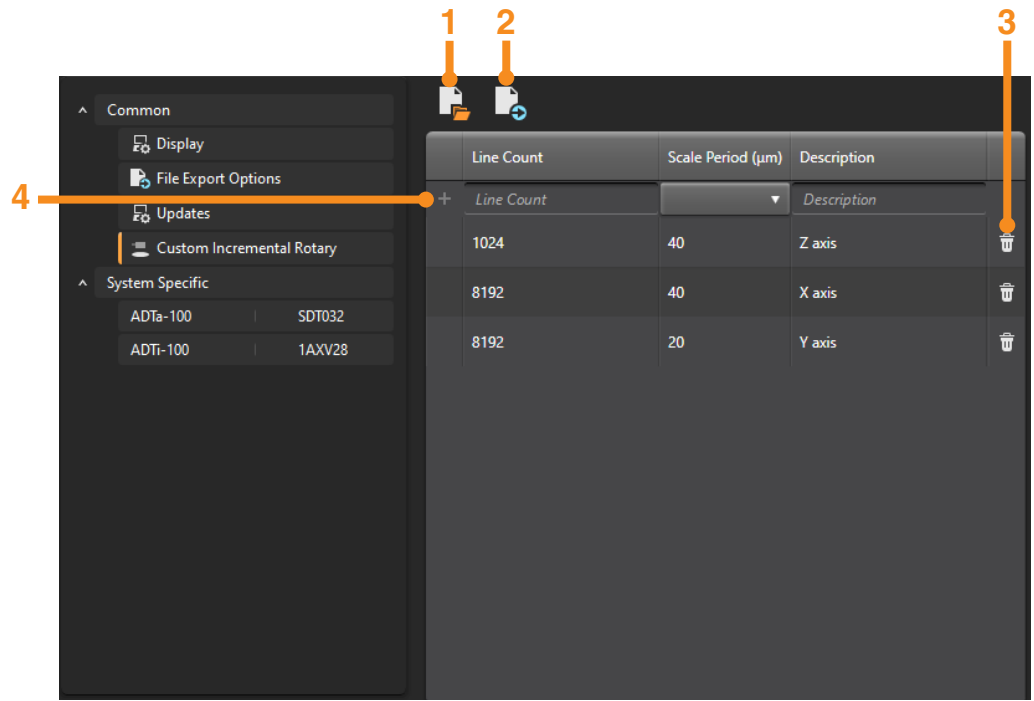

1. Import custom rings/discs from a file.
2. Export custom rings/discs to a file
3. Delete ring or disc
4. Add a new ring or disc (section 4.3.1)

4.3.1 Adding a ring or disc

To add a new custom rotary scale enter the line count of the ring or disc and select the scale period (20 µm or 40 µm) from the drop-down list. An optional description can be added to aid identification of the axis. The '+' will go green when all the relevant information is entered. Click '+' to add the new ring or disc. The new ring/disc will appear in the rotary selection menu (section 6.3).

IMPORTANT: If the line count or pitch are entered incorrectly the signal strength vs position plot and DRO count will be incorrect.

NOTES:

- The optical diameter displayed for discs (section 6.3) is calculated from the line count and scale period.
 - Only incremental rings or discs can be added as the absolute rings are determined by the readhead connected.
-

4.3.2 Editing a ring or disc

To edit a ring or disc double click on the chosen field and edit as required. Click on '✓' to accept and save the changes, or '✗' to return to the previous values.

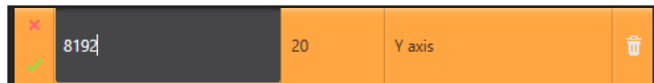

5. Using the ADT View software with ADTa-100

5.1 Overview

When the ADTa-100 is selected and connected to, the following window will display.

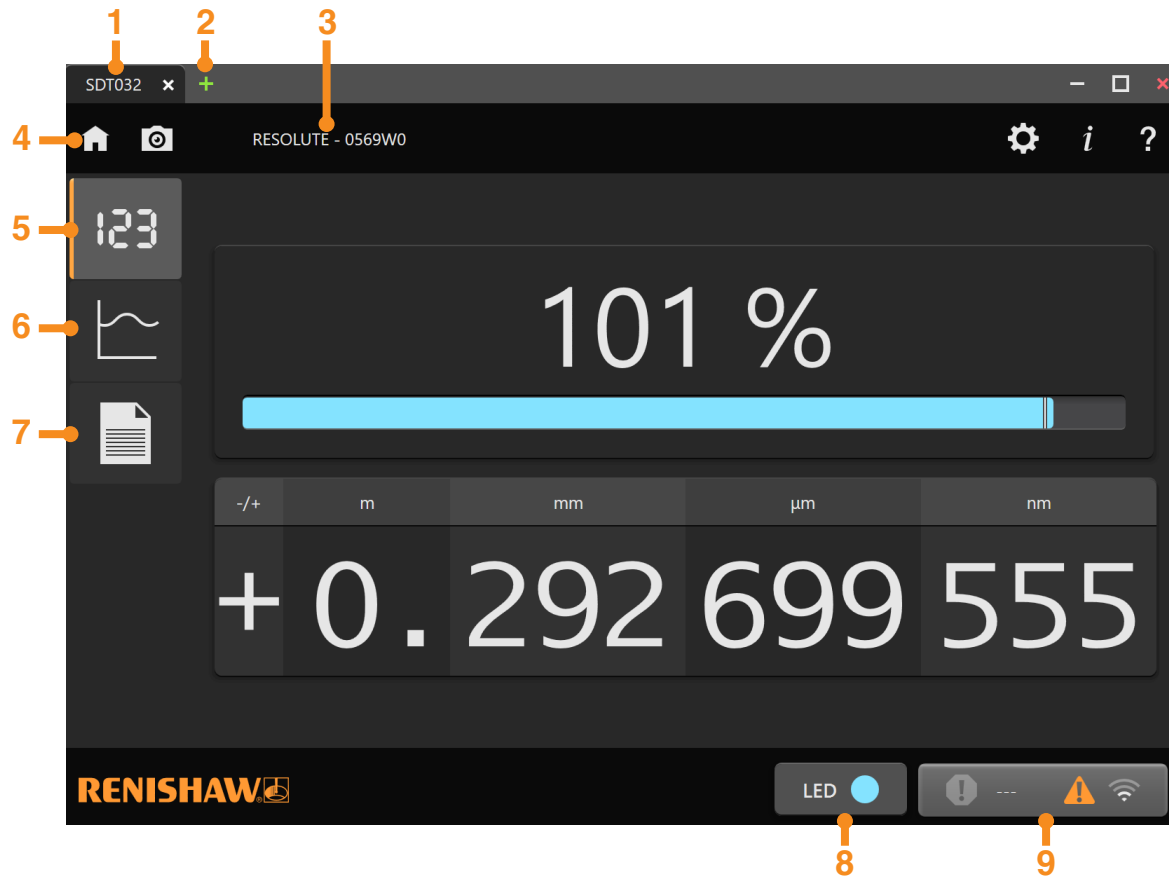

1. ADTa-100 serial number
2. Connect to another ADT. Opens ADT selection screen in a new tab (section 3.2.1).
3. Readhead type and serial number
4. Disconnect ADT and return to ADT selection screen (section 3.2.1)
5. Digital readout (DRO) and signal screen (section 5.2)
6. Signal strength vs position screen (section 5.3)
7. Configuration screen (section 5.4)
8. Readhead LED indicator. Repeats the colour displayed by the connected readhead's LED.
9. Alarm and warning log (section 5.2.4.2)

5.2 Digital readout (DRO) and signal screen



This screen is automatically displayed when the ADT_a is selected on the ADT View software. It provides information to assist with readhead set-up. The software will automatically detect the readhead type connected and display the linear or rotary signal screen accordingly.

Linear DRO and signal screen
(section 5.2.2.1)

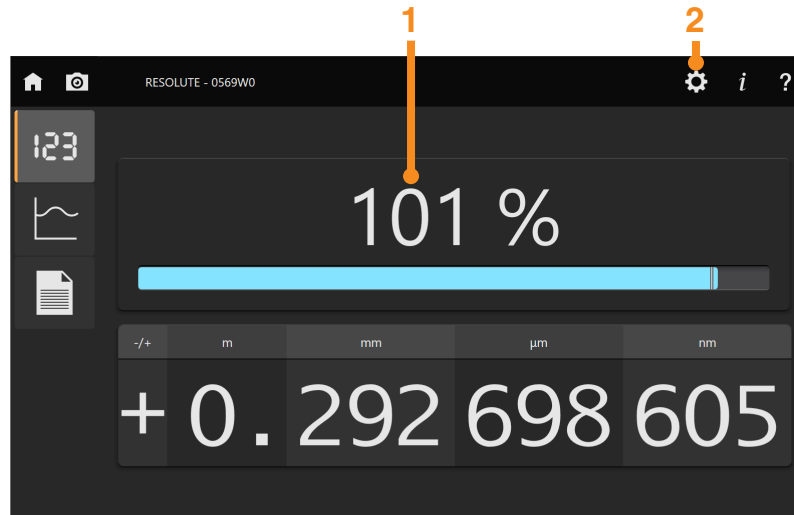

Rotary DRO and signal screen
(section 5.2.2.2)

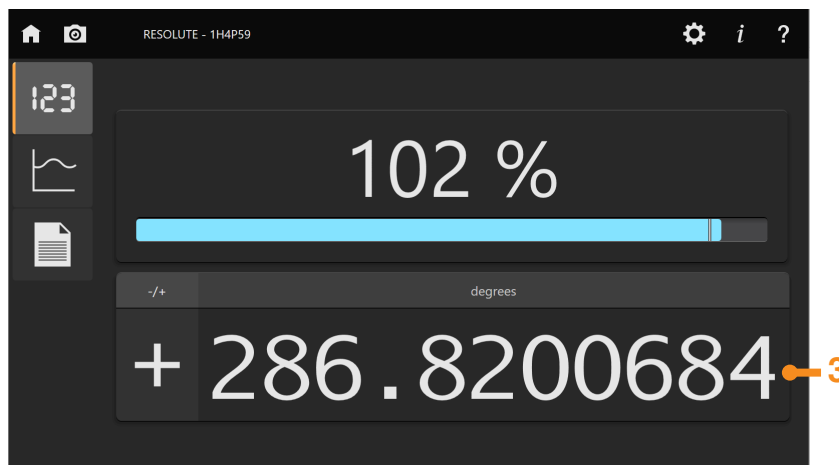

1. Signal strength indicator (section 5.2.1)
2. Settings (section 4)
 - Select DRO units
 - Enable set zero function
3. Digital readout (DRO) of the encoder position (section 5.2.2)

When an alarm or warning occurs, a pop-up describing the alarm or warning condition will be displayed.

See section 5.2.4 for more information on alarms and warnings.

NOTE: For more information on system installation and set-up refer to the relevant installation guide. These can be found at www.renishaw.com/encoderinstallationguides.

5.2.1 Signal strength

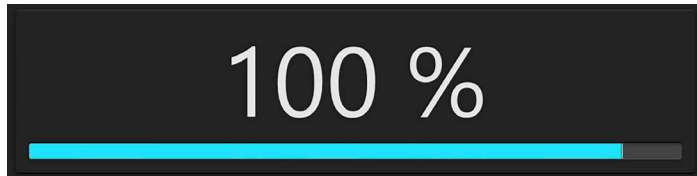

The signal strength is displayed as a percentage and on a signal bar. The signal bar colour matches the colour of the connected readhead's LED.

5.2.2 Digital readout of the encoder position

5.2.2.1 Linear position display

When a linear system is connected, the position can be displayed in either metric or encoder units.

The units can be selected in the settings window (section 4).

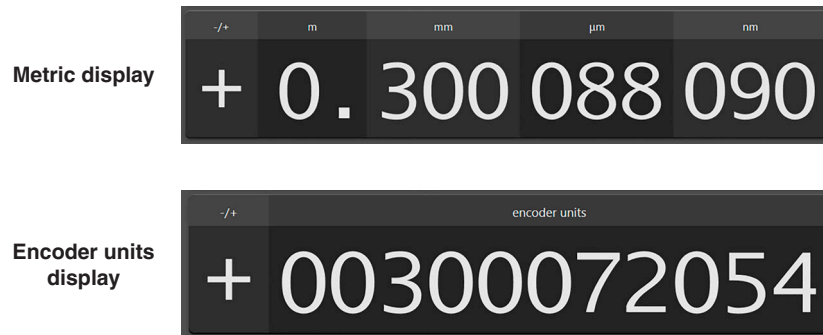

NOTE: When encoder units display is selected, each count represents one unit of encoder resolution.

Display Negative Numbers

When 'Display Negative Numbers' is selected the digital readout will display a negative count when the readhead passes the zero position interpreting the encoder output as a signed value. See section 5.2.3 for details on setting the zero position.

If 'Display Negative Numbers' is not selected the digital readout will wrap to the maximum value (word length x resolution) when it passes the zero position interpreting the encoder output as an unsigned value.

NOTE: Negative numbers are only available with BiSS, Panasonic and Yaskawa protocols.

5.2.2.2 Rotary position display

When a rotary system is connected, the position can be displayed in decimal degrees, degrees/minutes/seconds or as encoder units.

The units can be selected in the settings window (section 4).

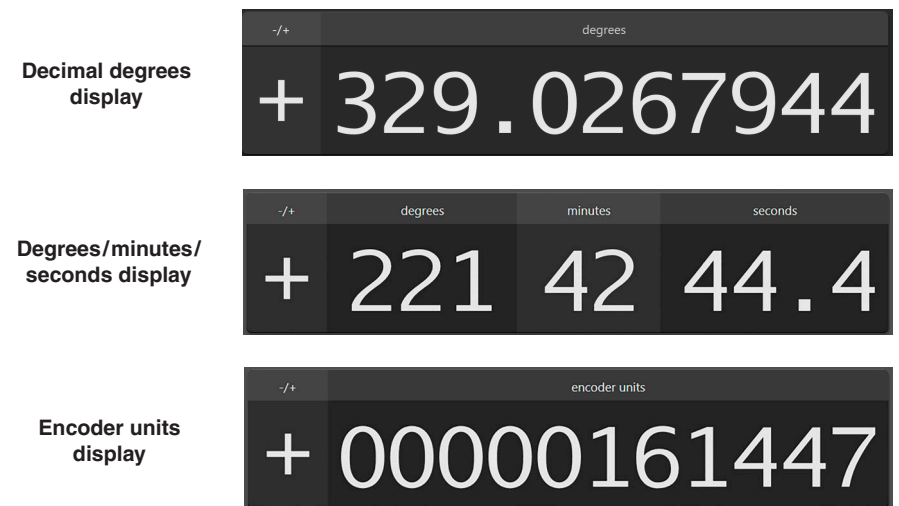

5.2.3 Set zero position function

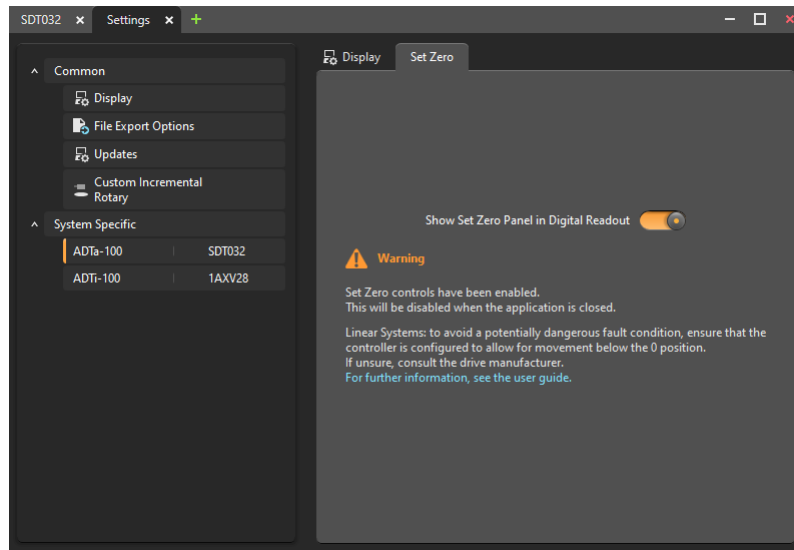

BiSS linear readheads only

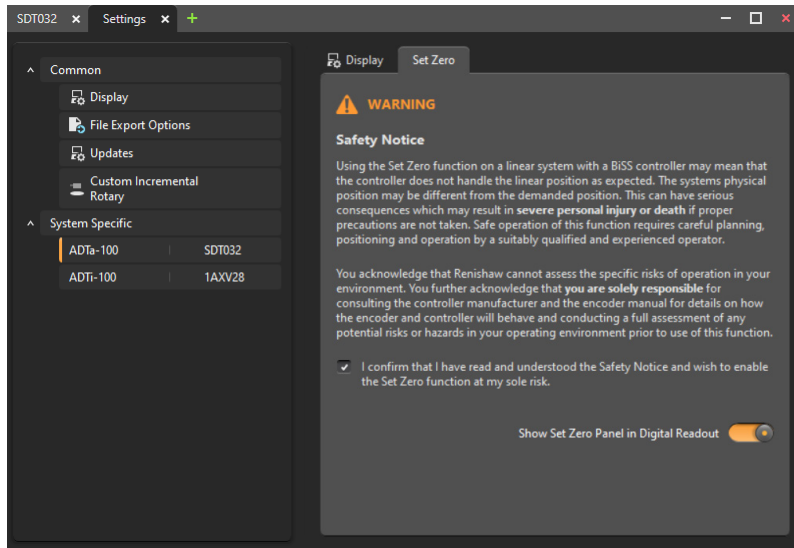

The 'Set Zero' function is enabled from the settings page (section 4). Once 'Show Set Zero Panel in Digital Readout' has been enabled new options will appear on the DRO screen. These will allow the user to zero at the current position (section 5.2.3.1), or zero at a defined position (section 5.2.3.2).

NOTE: For BiSS linear readheads the additional safety notice must be read and confirmed before set zero is possible.

- For safety reasons the set zero functionality will be disabled each time the software is closed. The Zero offset position will be retained in the readhead. Go to settings page (section 4) to enable it.
- The set zero selection option will only be available for readheads that support this functionality.
- When a zero offset is applied a warning message will be displayed in the bottom bar and, for BiSS linear systems only, a link to the safety notice.

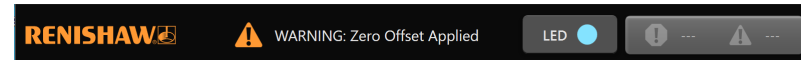

NOTE: Currently only readheads with BiSS, Panasonic or Yaskawa protocols have set zero functionality.

WARNINGS:

- Make sure the power to the readhead is not disconnected during the 'Write Zero Offset' and 'Clear Zero Offset' procedures. Failure to do this might result in readhead firmware corruption.
- For linear systems please ensure your controller is configured to allow for movement below the zero position when the set zero function is used. When traversing zero in the negative direction the encoder output will wrap to its maximum value (word length x resolution). If the controller is not expecting this behaviour it could result in a potentially dangerous fault condition. If you are unsure of this please consult your drive manufacturer before continuing.

5.2.3.1 Set zero at current position

Linear system

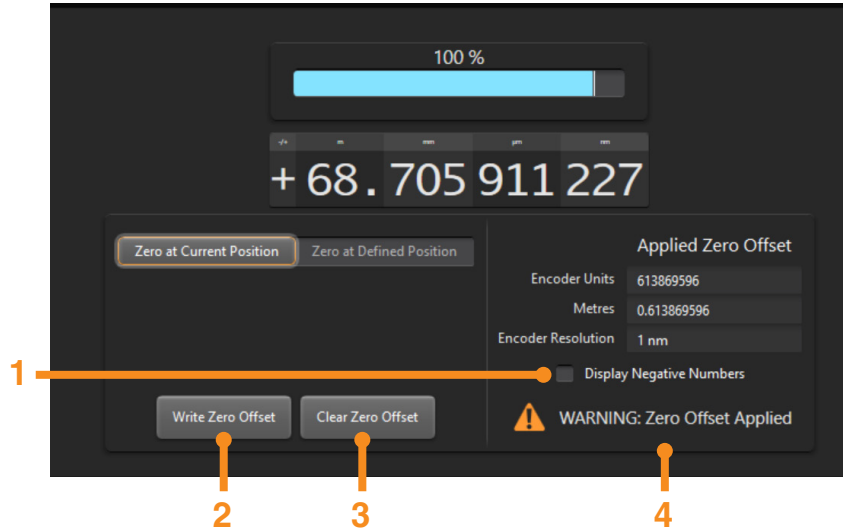

1. Display negative count when readhead passes zero position (section 5.2.2.1)
2. Rewrite the current position to be zero
3. Clear the applied zero – the zero position will be reset back to the factory zero position
4. Warning displayed when a zero offset has been applied

Rotary system

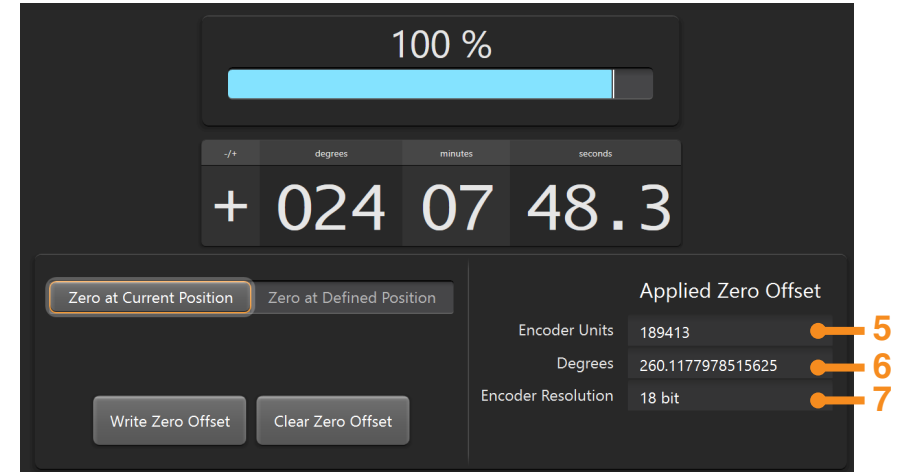

5. The applied offset from the factory zero in encoder units
6. The applied offset from the factory zero in metres (linear systems) or in degrees (rotary systems)
7. The resolution of the connected readhead

5.2.3.2 Set zero at defined position

Linear system

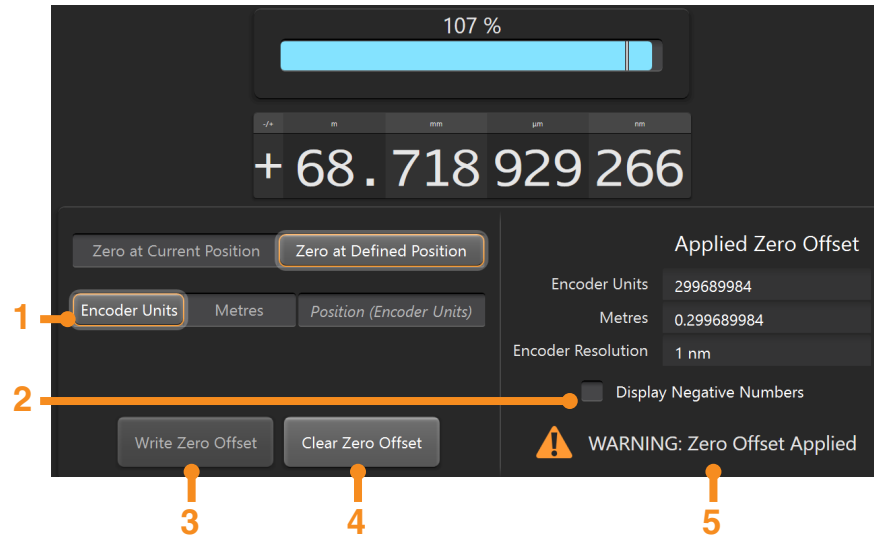

1. Select units and input the value required for the new zero position
2. Display negative count when readhead passes zero position (section 5.2.2.1)
3. Write the new zero position to the readhead. This is the Applied Zero Offset
4. Clear the applied zero – the zero position will be reset back to the factory zero position
5. Warning displayed when a zero offset has been applied

Rotary system

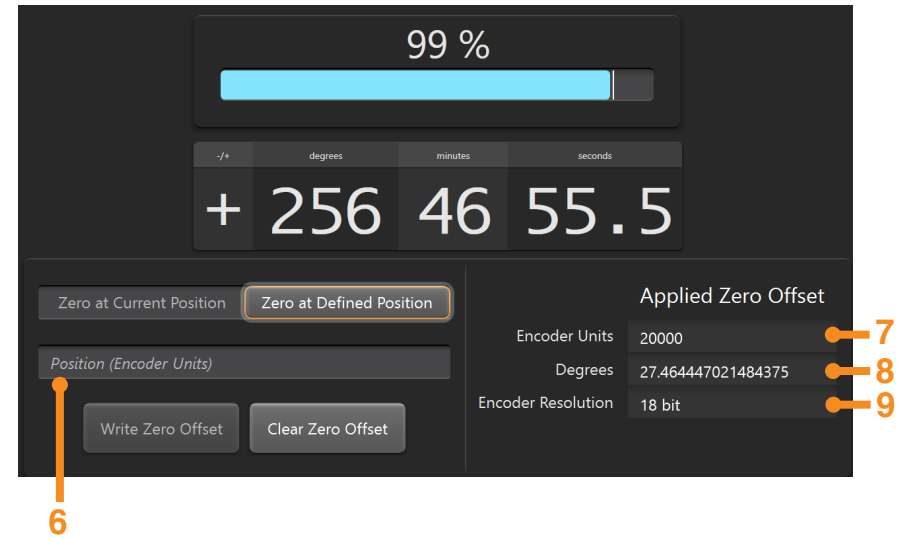

6. Input the value required for the new zero position
7. The applied offset from the factory zero position in encoder units
8. The applied offset from the factory zero position in metres (linear systems) or in degrees (rotary systems)
9. The resolution of the connected readhead



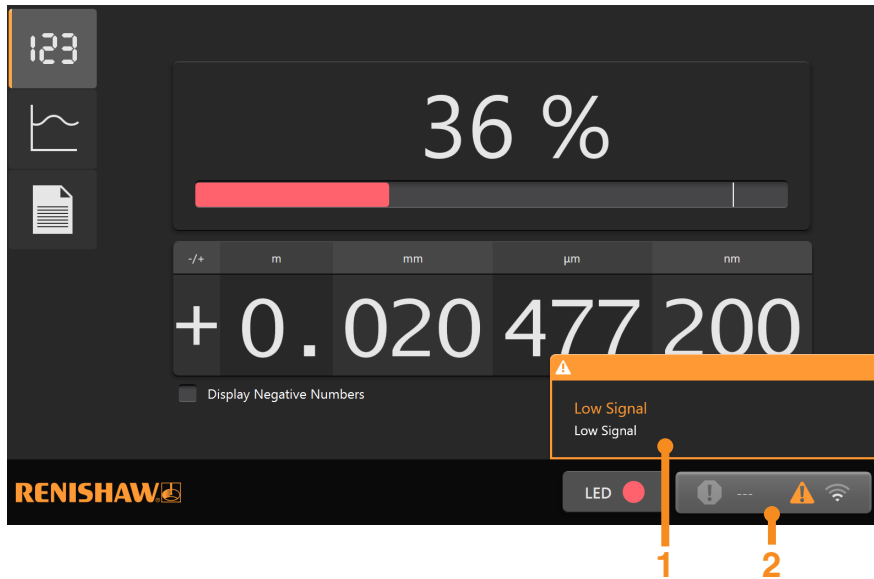

5.2.4 Alarms and warnings

5.2.4.1 Alarm and warning indication



1. An alarm or warning will be displayed on each screen via a pop-up describing the alarm or warning condition. This will be displayed for 3 seconds when an alarm or warning condition occurs.
2. The last alarm or warning that occurred will be indicated until the alarm and warning log is cleared. Click the button to open the alarm and warning log (section 5.2.4.2).

Possible alarms and warnings

Symbol	Warning/Alarm
	Position alarm
	Overspeed warning/alarm
	Low signal warning
	Temperature warning/alarm

5.2.4.2 Alarm and warning log



The log contains information about all alarms and warnings that have occurred since the system was switched on.

ADT	ADT S/N	Readhead S/N	Alarm / Warning	Description	Date	Time
ADTa-100	SDT032	0569W0	!	Position	22/03/2021	08:51:48
			!	Low Signal	22/03/2021	08:51:48
			!	Position	22/03/2021	08:51:45
			!	Low Signal	22/03/2021	08:51:45
			!	Position	22/03/2021	08:51:34
			!	Low Signal	22/03/2021	08:51:34
			!	Low Signal	22/03/2021	08:51:15

1. Alarm and warning log
2. Clear the alarms and warnings in the log
3. ADT selection

NOTE: Only the alarms and warnings of the selected ADT are displayed

4. Error icons light up if error is currently active in the system

5.3 Signal strength vs position screen



The signal strength vs position screen plots the signal size vs position as either a rotary or linear plot depending upon the connected readhead.

5.3.1 Linear systems

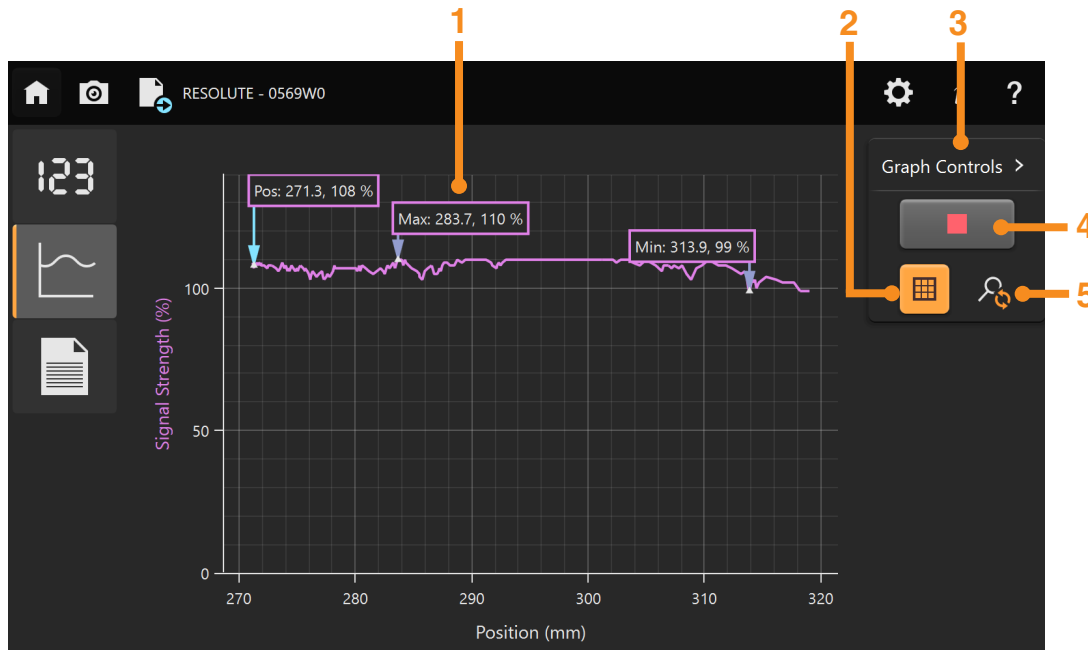

1. Plot of signal strength vs position

NOTE: The plot can be zoomed and panned. See section 5.3.3.2 for more information.

2. Enable/disable grid lines
3. Select to show/hide Graph Controls

NOTE: Only the alarms and warnings of the selected ADT are displayed.

4. Start/stop a plot (section 5.3.3.1)
5. Reset zoom

When an alarm or warning occurs, a pop-up describing the error condition will be displayed. See section 5.2.4 for more information on alarms and warnings.

The maximum and minimum signal strengths and the signal strength at the current position are shown in purple boxes.

NOTES:

- The signal plot will always be displayed in mm.
- The maximum speed of travel for a useful signal strength vs position plot is 0.5 m/s.
- An improved plot resolution is possible at slower speeds.

5.3.2 Rotary systems

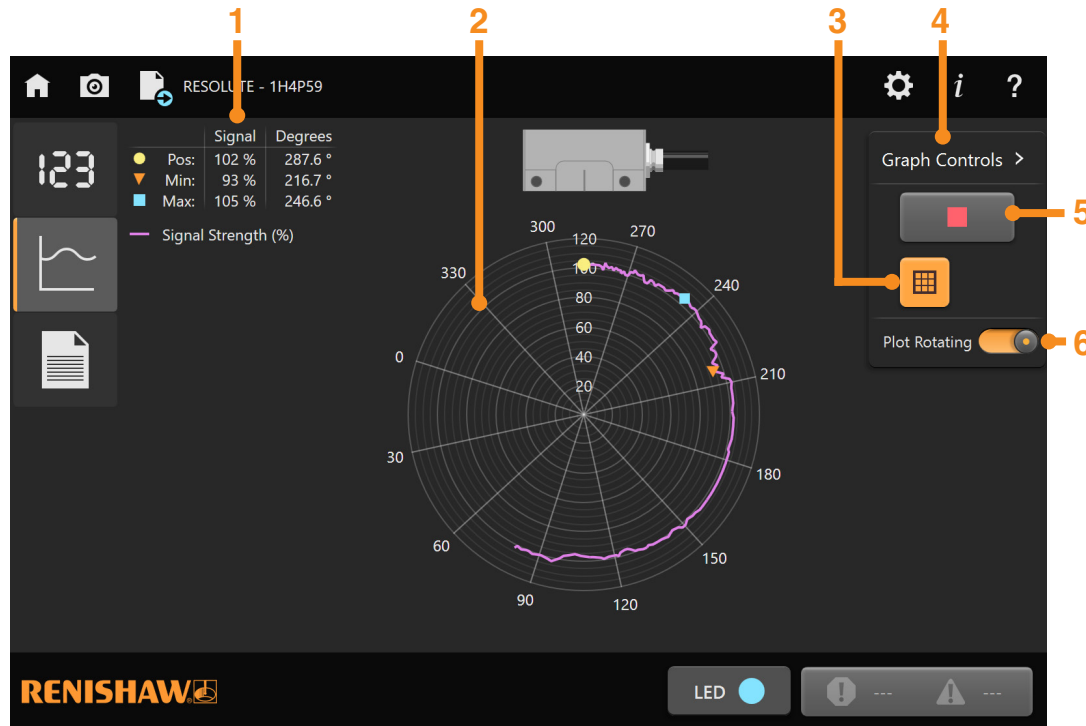

1. Signal strength at the current position and maximum and minimum signal strength positions
2. Plot of signal strength vs position
3. Enable/disable grid lines
4. Select to show/hide Graph Controls
5. Start/stop a plot (section 5.3.3.1)
6. Switch plot rotation on/off (section 5.3.3.3)

When an alarm or warning occurs, a pop-up describing the error condition will be displayed. See section 5.2.4 for more information on alarms and warnings.

NOTES:

- The signal plot will always be displayed in degrees.
- The maximum speed that the readhead can travel over the ring to display a useful signal strength vs position plot is 0.5 m/s. This is approximately equivalent to 50 rpm with a 200 mm diameter ring.
- An improved plot resolution is possible at slower travelling speeds.

5.3.3 Graph controls

5.3.3.1 Starting/stopping a plot

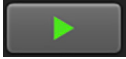

Click the green arrow to start a plot. The arrow will change to a red square whilst data is being recorded. To stop a plot, click on the red square.

NOTES:

- When the readhead direction is reversed, the trace direction will reverse and previous data will be overwritten.
- Changing screens during data plotting will clear the data and a new plot will restart automatically when the signal strength vs position screen is reselected. Stop the plot before switching screens to retain the data.

5.3.3.2 Zooming and panning the plot (linear only)

The plot can be zoomed and panned using a mouse, trackpad, touchscreen or similar.

To pan using a mouse:

- Point the mouse at the trace, click and hold the right mouse button and drag the trace left, right, up or down.

To zoom using a mouse/trackpad:

- Click with the left mouse button then drag the mouse to draw a box around the section of interest

Or

- Move the mouse wheel to zoom the whole plot in or out.

To zoom and pan using a touch screen device.

- Pan by swiping finger along the screen in the direction you want to move the plot.
- Zoom using a thumb and finger. Move them away from each other to zoom in and 'pinch' them together to zoom out.

NOTE: When zooming or panning during a 'live' plot the data will continue to be plotted but only the selected area will be displayed and the plot will no longer scroll. To display the whole plot, select 'Reset zoom' (section 5.3.1).

5.3.3.3 Plot rotation (rotary only)

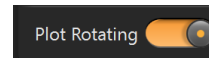

When 'Plot Rotating' is selected the graph rotates and the current position of the readhead remains at the top of the plot.

When 'Plot Rotating' is deselected the plot axes remain stationary with 90 degrees displayed at the top and the current position rotates around the graph.

NOTE: It is recommended that 'Plot Rotating' is disabled when using the rotary display at higher speeds.

5.4 Configuration screen



The configuration screen provides information about the readhead and ADTa-100 connected.

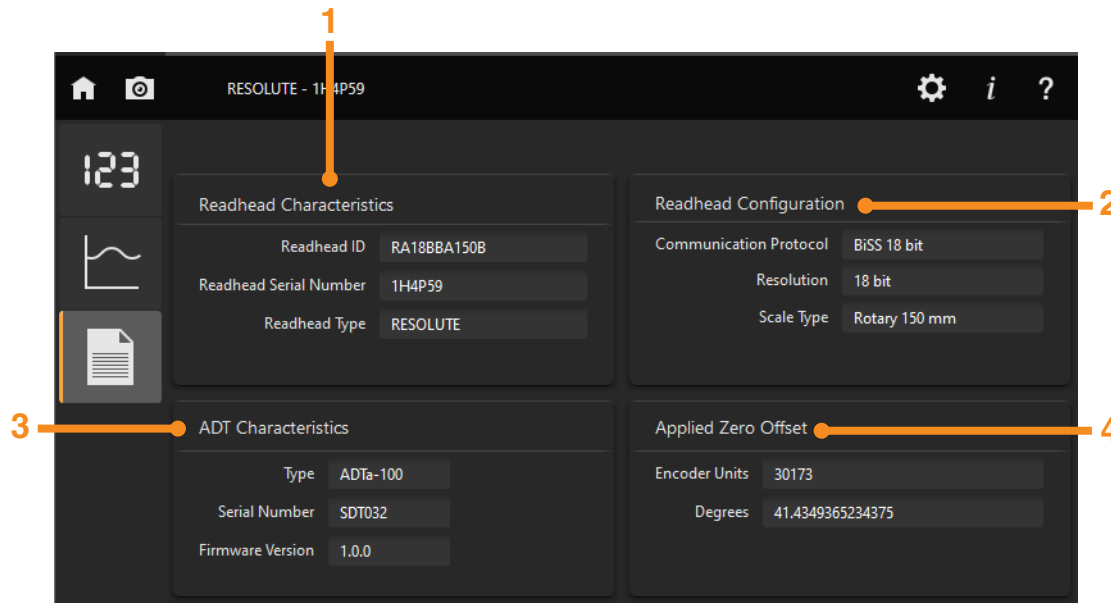

1. Readhead Characteristics
 - Read from the data stored in the connected readhead
2. Readhead Configuration
 - Read from the data stored in the connected readhead
3. ADTa-100 Characteristics
4. Applied Zero Offset
 - Display zero offset from DRO screen (section 5.2.3)

6. Using the ADT View software with ADTi-100

6.1 Analogue variants of QUANTiC only

When connecting an analogue variant of QUANTiC the following will be displayed when the readhead and ADT are connected. Check the 'ENCODER OUTPUT' of the ADTi-100 is correctly terminated (section 2.2) and click OK.

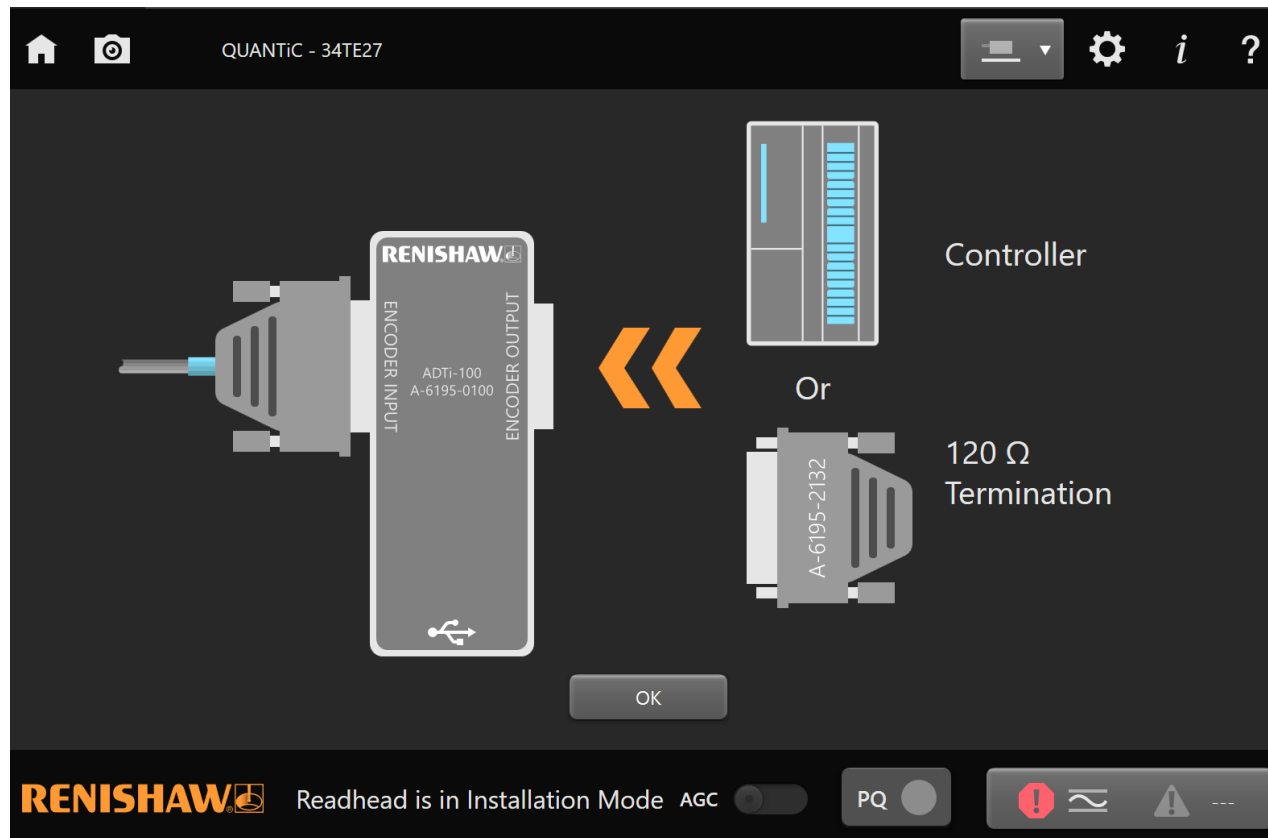

6.2 Overview

This signal screen is automatically displayed when the ADTi-100 with readhead connected is selected.

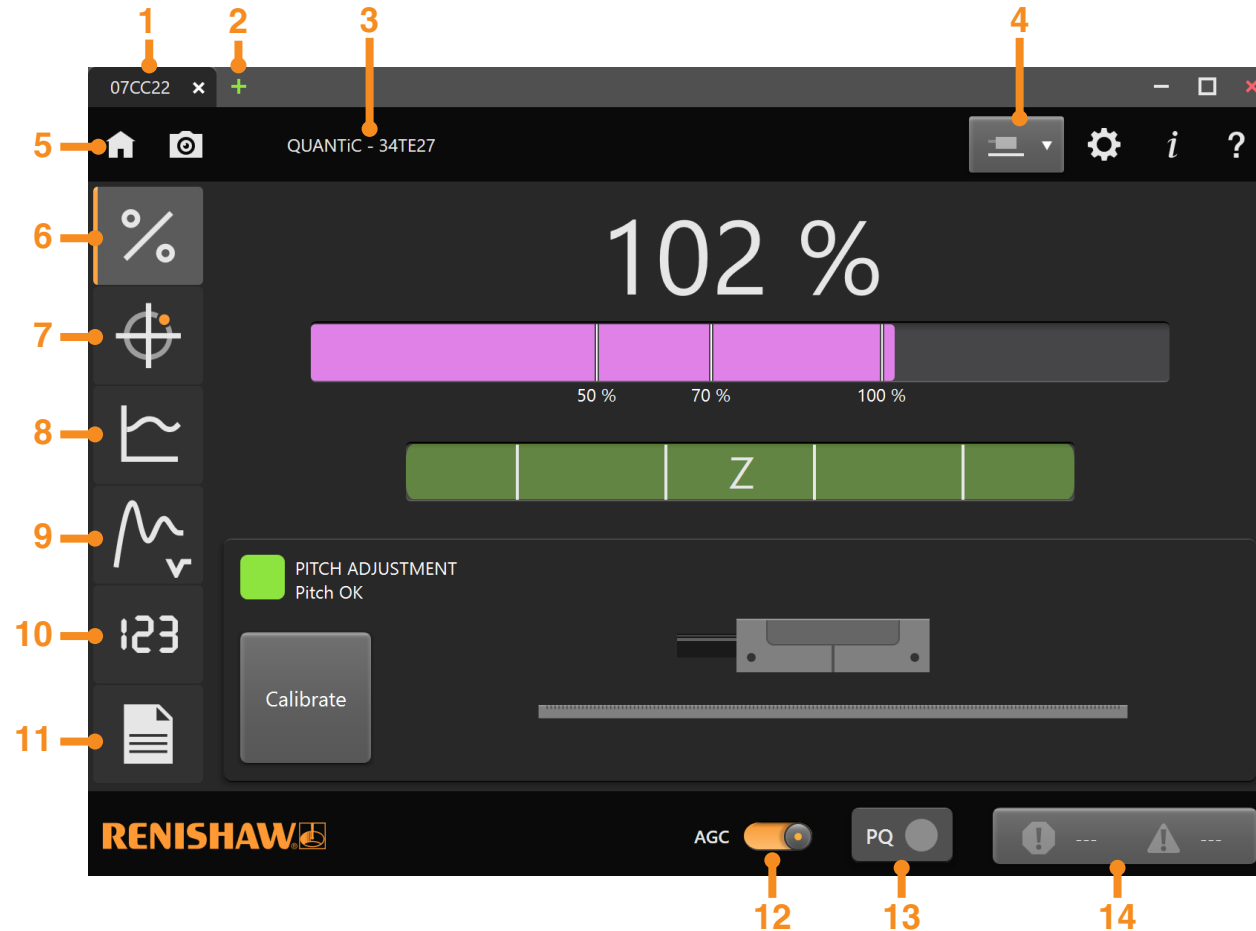

1. ADTi-100 serial number
2. Connect to another ADT. Opens ADT selection screen in a new tab (section 3.2.1).
3. Readhead type and serial number
4. Linear/rotary scale selection (section 6.3)
5. Disconnect ADT and return to ADT selection window (section 3.2.1)
6. Signal screen (section 6.4)
7. Lissajous (X-Y) screen (section 6.5)
8. Signal strength vs position screen (section 6.6)
9. Velocity screen (section 6.7)
10. Digital readout (DRO) screen (section 6.8)
11. Configuration screen (section 6.9)
12. Automatic Gain Control (AGC) switching (section 6.4.5)
13. Limit indication where applicable
14. Alarm and warning log (section 6.4.6)

6.3 Linear/Rotary selection

The software will, where possible, automatically detect the readhead type connected and display a linear or rotary plot accordingly. When the readhead type cannot be automatically detected the display will default to linear selection.

To manually change the scale type, select linear or rotary from the drop-down menu.

On first selection of the rotary signal strength vs position (section 6.6.2) or DRO (section 6.8.2) screens a drop-down menu containing all relevant rotary scale options for the connected readhead variant will be displayed.

Select the relevant rotary scale and click 'OK'. Special ring/discs can be added in the 'Custom Incremental Rotary' section of the settings window (section 4.3)

Ring selection

Scale Period 40 µm Resolution 0.1 µm

Line Count	Counts Per Revolution	Outer Diameter (mm)	Description
4096	1638400	52	---
4500	1800000	57	---
5920	2368000	75	---
7400	2960000	94	---
7872	3148800	100	---
8100	3240000	103	---

Show All OK

Disc selection

Scale Period 40 µm Resolution 0.1 µm

Line Count	Optical Diameter (mm) (Calculated)	Counts Per Revolution	Outer Diameter (mm)	Description
1024	13.04	409600	17	A-9405-4017
1250	15.92	500000	20	A-9405-4020
1650	21.01	660000	25	A-9405-4025
1800	22.92	720000	27	A-9405-4027
2048	26.08	819200	30	A-9405-4030
2500	31.83	1000000	36	A-9405-4036

Show All OK

NOTES:

- Only the rotary scales compatible with the readhead connected will be displayed. 'Show All' displays all rotary scales with the relevant scale pitch.
- For discs the optical diameter is calculated from the line count and scale period.

6.4 Signal screen



The signal screen provides information to assist with readhead set-up and calibration.

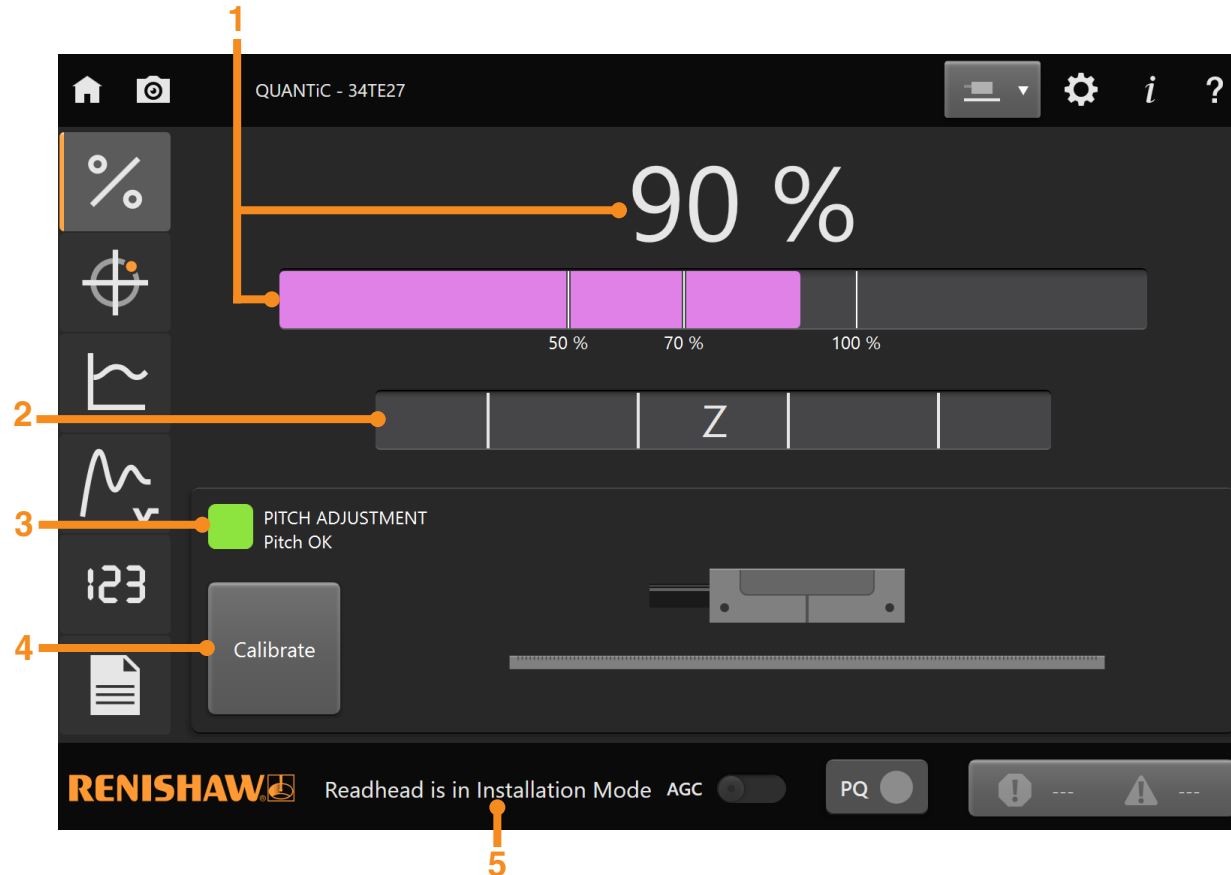

1. Signal strength indication (section 6.4.1)
2. Reference mark phasing indication (section 6.4.2)
3. Pitch indication where applicable (section 6.4.4) or Calibration instructions (section 6.4.5)
4. Calibration initiation (section 6.4.5)
5. Readhead mode (section 6.4.3)

When an alarm or warning occurs, a pop-up describing the error condition will be displayed. See (section 6.4.6) for more information on alarms and warnings.

NOTE: For more information on system installation and set-up refer to the relevant installation guide. These can be found at www.renishaw.com/encoderinstallationguides.

6.4.1 Signal strength

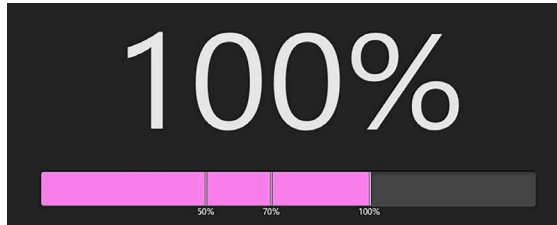

The signal strength is displayed as a percentage and on a signal bar. The signal bar remains purple at all signal amplitudes regardless of AGC status.

6.4.2 Reference mark phasing

The reference mark phasing is displayed as a coloured bar; the length and colour of the bar indicate the phasing of the last reference mark passed. The bar flashes brightly for a few seconds as the reference mark is passed then fades, retaining the colour of the last reference mark.

Well phased reference mark;
no action required



Poorly phased reference mark;
recalibration recommended
(section 6.4.5).



Incorrectly phased reference
mark, recalibrate the system
(section 6.4.5).

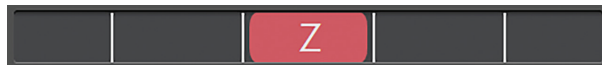

6.4.3 Readhead mode

Installation mode

When the readhead is first switched on (out of the box), or after factory defaults have been restored (section 6.9.1) the readhead is in installation mode. 'Readhead is in Installation Mode' will be displayed in the bottom bar.

Readhead is in Installation Mode

NOTE: AGC is disabled in installation mode and cannot be switched on. Set the readhead up as detailed in the relevant installation guide, these can be found at www.renishaw.com/encoderinstallationguides.

Calibration mode

Once the readhead has been set up the system must be calibrated (section 6.4.5), 'Readhead is in Calibration Mode' is displayed in the bottom bar during calibration.

Readhead is in Calibration Mode

NOTE: AGC is disabled in calibration mode and cannot be switched on.

Normal mode

Once the readhead has been calibrated the incremental and reference mark values are stored in the readhead and 'Calibration Sequence Complete' will be displayed briefly in the bottom bar. The readhead will automatically return to normal running mode and no text will be displayed in the bottom bar.

NOTE: AGC is automatically enabled once the calibration sequence is completed unless it had been switched off prior to calibration.

6.4.4 Pitch indication

During installation mode and normal operation the pitch of the readhead is displayed. The colour of the indicator and arrows will change depending on the pitch of the readhead. The arrows show the direction the readhead should be adjusted.

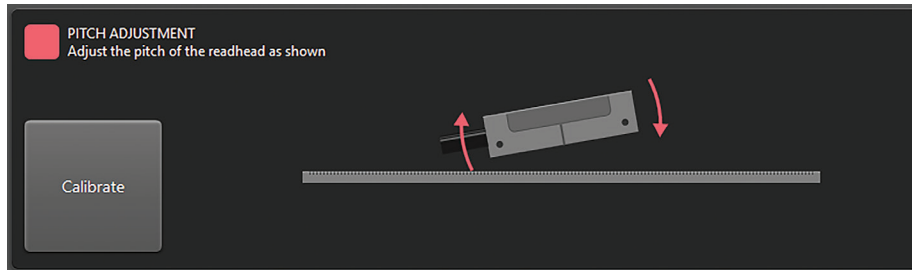

Green	The pitch of the readhead is optimum, no adjustment is required.
Orange	The pitch of the readhead is within tolerance but adjustment is recommended to optimise performance. Adjust pitch of the readhead as indicated.
Red	The pitch of the readhead is out of tolerance. Adjust pitch of the readhead as indicated.

NOTES:

- The pitch is not displayed when the signal size is less than 10% or when the system is in calibration mode.
- Pitch indication is not available on ATOM DX readheads.

6.4.5 System calibration

IMPORTANT: Ensure signal size is greater than 70% before initiating calibration. Refer to the relevant installation guide for information on system installation and set-up. These can be found at www.renishaw.com/encoderinstallationguides.

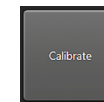

To initiate calibration, click the Calibrate button. 'Readhead is in Calibration Mode' will be displayed in the bottom bar (section 6.4.3).

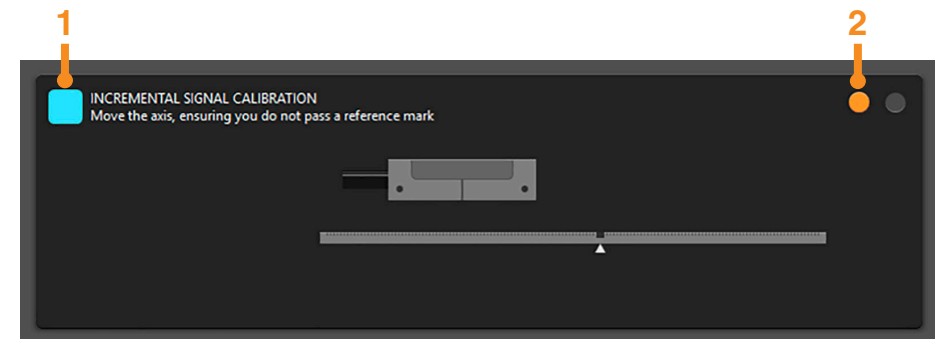

1. The blue indicator will single flash and 'INCREMENTAL SIGNAL CALIBRATION' will be displayed.
2. The first of two indicators (showing the 2 phases of calibration) will be orange.

Follow the instructions on the screen to calibrate the incremental signals.

NOTE: If the signal level is less than 70% a pop-up box will open: 'Unable to Start Calibration'. Restore factory defaults (section 6.9.1) and refer to the relevant installation guide for more information on system set-up.

When the incremental signal calibration is complete the system will automatically enter reference mark calibration. If you do not have a reference mark click the Exit Calibration button.

NOTE: The incremental calibration values are automatically stored in the readhead.

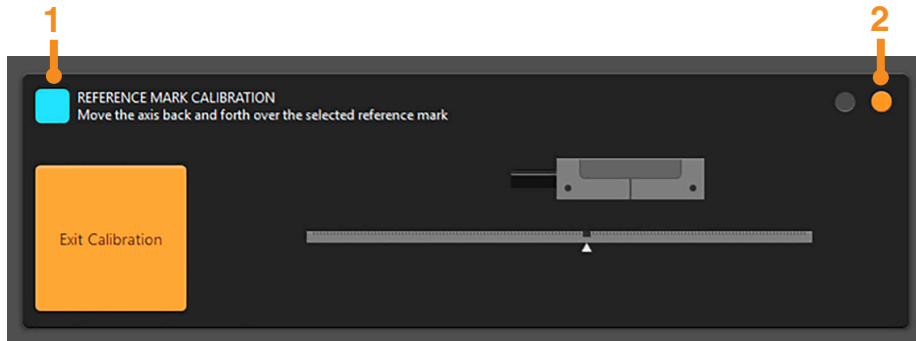

1. The blue indicator will double flash and 'REFERENCE MARK CALIBRATION' will be displayed.
2. The second of two indicators will be orange indicating the incremental signals have been successfully calibrated and the readhead is in reference mark calibration mode.

Follow the instructions on the screen to calibrate the selected reference mark.

Once reference mark calibration is complete the flashing blue indicator will automatically change to display a green indicator and 'Calibration Sequence Complete' for approximately 3 seconds before reverting to display readhead pitch information (section 6.4.4). Automatic Gain Control (AGC) will automatically be enabled when calibration is complete unless it was disabled prior to calibration.

Analogue variant of QUANTiC only. If the output termination of the ADTi-100 is not correct (section 2.2) the termination reminder (section 6), will pop up on completion of calibration and the system may display a termination alarm. A termination error will not be displayed when the readhead is in calibration mode.

NOTES:

- In Installation and Calibration modes the AGC is disabled and cannot be switched on.
- AGC is enabled as default during normal operation, to switch AGC off select the toggle switch on the bottom bar (section 6).

AGC on



AGC off



6.4.6 Alarms and warnings









6.4.6.1 Alarm and warning indication



An alarm or warning will be displayed on the signal screen in several ways.

1. Whilst an alarm or warning is asserted, a red alarm symbol or an orange warning triangle will be displayed next to the signal size. Click the indication to open the alarm and warning log (section 6.4.6.2). The indication will remain until the system is no longer in error.
2. A pop-up notification describing the alarm or warning condition will be displayed when an error occurs. The pop-up is visible on all screens.
3. The last alarm or warning that occurred will be displayed in the bottom bar until the log is cleared. Click the button to open the alarm and warning log (section 6.4.6.2).

Possible alarms and warnings (dependent on readhead; see section 6.9 for information on readhead configuration):

Symbol	Alarm 	Warning 
	Automatic Offset Compensation out of range	Automatic Offset Compensation
	Automatic Balance Control out of range	Automatic Balance Control
	Reference mark error	Reference mark
	Signal size too small	-
	Signal size too large	-
	Overspeed	-
	Incorrect termination ¹ (analogue only)	-

¹ Calibration and normal running mode only

6.4.6.2 Alarm and warnings log



The log contains information about the last error that occurred before the system was switched off and all alarms and warnings that have occurred since the system was switched on.

ADT	ADT S/N	Readhead S/N	Alarm / Warning	Description	New / Old	Date	Start	End
ADTi-100	07CC22	34TE27	!	Low Signal - Signal is too low for reliable operation	New	13/10/2021	13:51:34	Active
ADTi-100	SDT021	0569W0	!	High Signal - Signal is too high for reliable operation	New	13/10/2021	13:51:29	13:51:31
			!	Low Signal - Signal is too low for reliable operation	New	13/10/2021	13:51:03	13:51:29
			!	Low Signal - Signal is too low for reliable operation	Old	---	---	---

1. Alarm and warnings log

- Old errors occurred before the last time the system was switched off

NOTE: Some readhead variants will only display the time the alarm was triggered, not the end time or if they are still active.

2. Clear all alarms and warnings in the log and the readhead

3. ADT selection

NOTE: Only the alarms and warnings of the selected ADT are displayed.

6.5 Lissajous (X-Y) screen



The Lissajous screen shows a plot of the readhead's internal cosine (X) and sine (Y) signals.

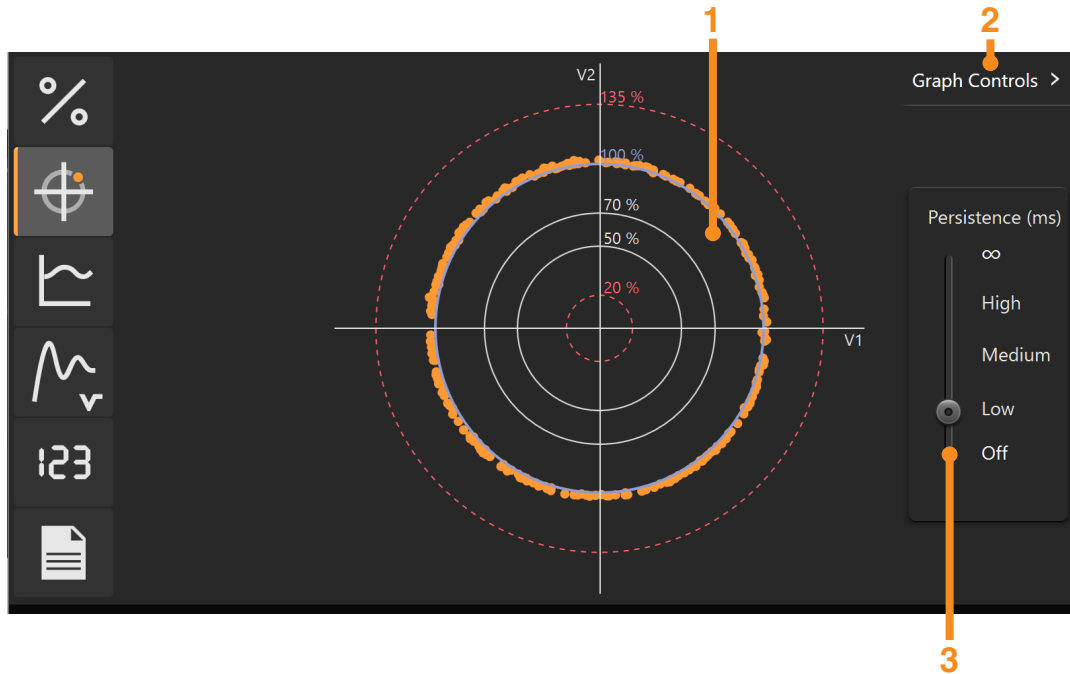

1. Lissajous plot
2. Select to show/hide Graph Controls
3. Slide bar to vary Lissajous persistence

When an alarm or warning occurs, a pop-up describing the error condition will be displayed. See section 6.4.6 for more information on alarms and warnings.

6.6 Signal strength vs position screen



The signal strength vs position screen plots the signal size vs position in either a rotary or linear plot. The software will, where possible, automatically detect the readhead type connected and display a linear or rotary plot accordingly. When the readhead type cannot be automatically detected the display will default to linear selection. See section 6.3 for details of linear and rotary selection.

6.6.1 Linear system

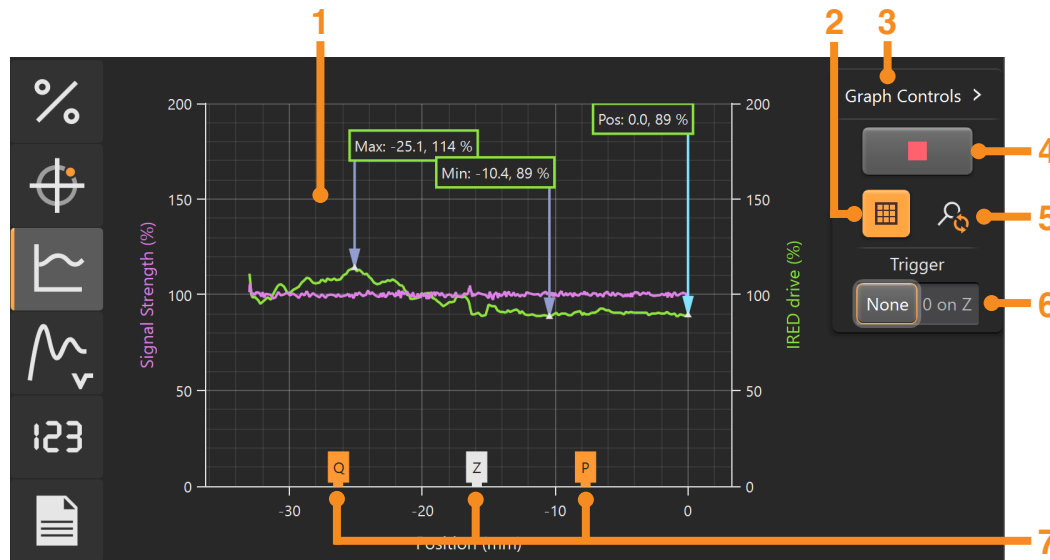

1. Plot of the signal size and IRED drive along the axis (section 6.6.3)

NOTE: The plot can be zoomed and panned. See section 6.6.4.2 for more information.

2. Enable/disable grid lines
3. Select to show/hide Graph Controls
4. Start/stop a plot (section 6.6.4.1)
5. Reset zoom
6. Trigger mode selection (section 6.6.4.4)
7. Reference mark (Z) and limit (P & Q) positions along the axis where applicable

When an alarm or warning occurs, a pop-up describing the error condition will be displayed. See section 6.4.6 for more information on alarms and warnings.

NOTE: The signal plot will always be displayed in mm.

6.6.2 Rotary system

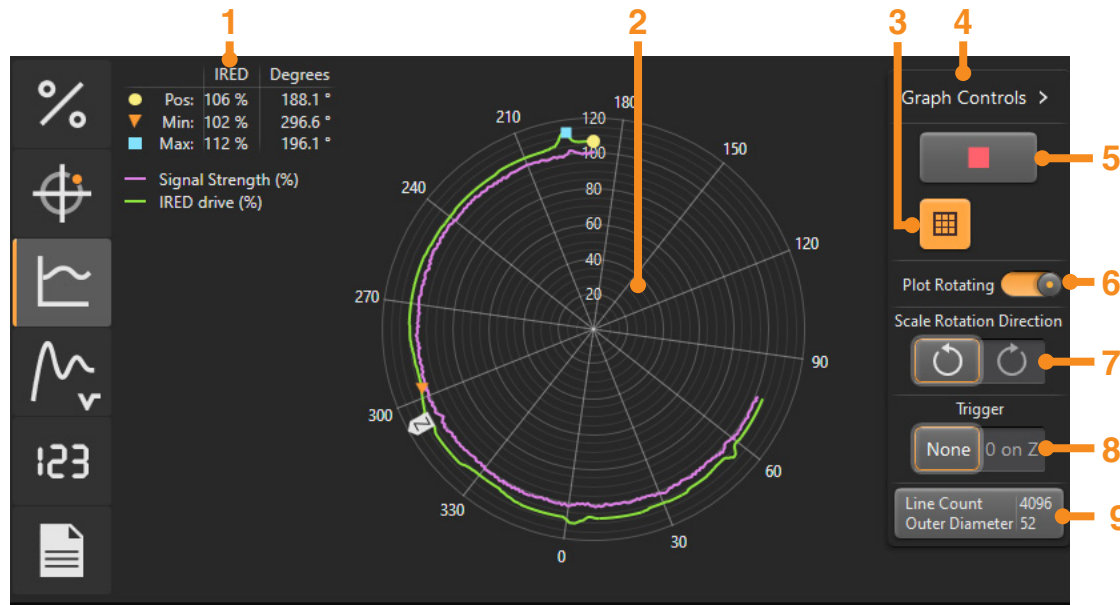

1. Signal strength (AGC off) or IRED drive (AGC on) at the current position and maximum and minimum positions
2. Plot of the signal size and IRED drive around the axis (section 6.6.3)
3. Enable/disable grid lines
4. Select to show/hide Graph Controls
5. Start/stop a plot (section 6.6.4.1)
6. Switch plot rotation on/off (section 6.6.4.3)
7. Switch scale rotation direction (section 6.6.4.3)
8. Trigger mode selection (section 6.6.4.4)
9. Display current ring/disc selection. Click to select a new ring/disc type.

When an alarm or warning occurs, a pop-up describing the error condition will be displayed. See section 6.4.6 for more information on alarms and warnings.

NOTE: The signal plot will always be displayed in degrees.

6.6.3 Signal strength and IRED drive plots

The graph displays 2 plots which automatically rescale as the readhead is moved along the axis:

- Signal strength vs position (purple plot).
- IRED drive vs position (green plot). The IRED drive is the relative current through the infrared emitter (IRED) in the readhead.

The limit and reference mark positions are displayed along the bottom of the linear plot where applicable.

NOTES:

- Maximum speed of travel for a useful signal strength vs position plot is 1 m/s. An improved plot resolution is possible at slower speeds.
 - During installation mode changing direction of the readhead at speed may result in multiple reference marks or limits being plotted on the graph; this is due to the speed of movement being faster than the data plot rate.
 - The plot will automatically stop if the signal size becomes too low for reliable data to be plotted. Click the green triangle to restart the plot. The data will be cleared when the plot is restarted (section 6.6.4.1).
-

Linear plot (AGC enabled)

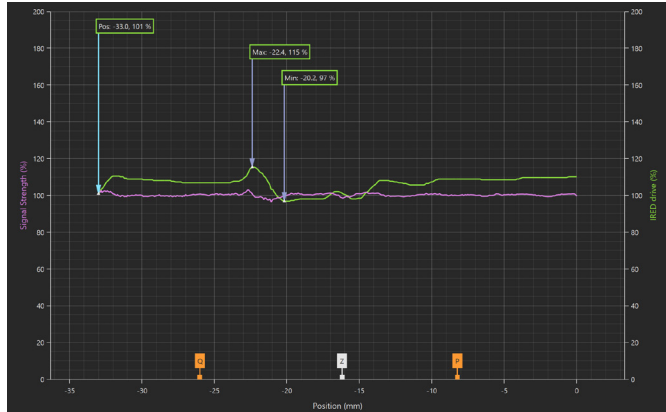

Auto Gain Control (AGC) enabled (default):

- The maximum, minimum and current IRED drive are displayed
- For a good set-up, the IRED drive will vary whilst the signal strength plot should remain constant at approximately 100%

Rotary system (AGC disabled)

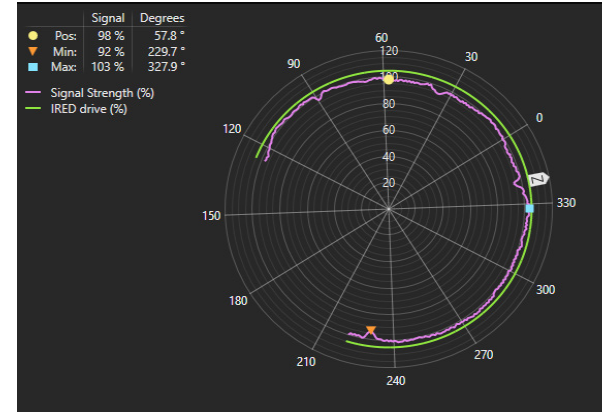

Auto Gain Control (AGC) disabled:

- The maximum, minimum and current signal size are displayed
- The signal strength will vary along the plot whilst the IRED drive plot remains constant

6.6.4 Graph controls

6.6.4.1 Starting/stopping a plot



Click the green arrow to start a plot, the plot will automatically rescale as the readhead is moved along/around the axis. The arrow will change to a red square whilst data is being recorded. To stop the plot, click on the red square.

NOTES:

- If the readhead goes into low signal alarm the plot will automatically stop and 'Graph stopped' will display in the bottom right of the graph. When the green arrow is pressed to restart the plot the current data will be cleared and a new plot started. The arrow will be greyed out if the readhead is in low signal alarm.
 - When the readhead direction is reversed, the trace direction will reverse and previous data will be overwritten.
 - Changing screens during data plotting will clear the data and a new plot will restart automatically when the signal strength vs position screen is reselected. Stop the plot before switching screens to retain the data.
-

6.6.4.2 Zooming and panning the plot (linear only)

The plot can be zoomed and panned using a mouse, trackpad, touchscreen or similar.

To pan using a mouse:

- Point the mouse at the trace, click and hold the right mouse button and drag the trace left, right, up or down.

To zoom using a mouse/trackpad:

- Click with the left mouse button then drag the mouse to draw a box around the section of interest
- Or
- Move the mouse wheel to zoom the whole plot in or out.

To zoom and pan using a touch screen device.

- Pan by swiping finger along the screen in the direction you want to move the plot.
- Zoom using a thumb and finger. Move them away from each other to zoom in and 'pinch' them together to zoom out.

NOTE: When zooming or panning during a 'live' plot the data will continue to be plotted but only the selected area will be displayed and the plot will no longer scroll. To display the whole plot, select 'Reset zoom'.

6.6.4.3 Plot rotation (rotary only)

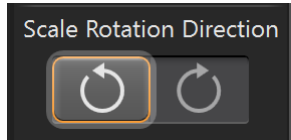

Select plot direction to match shaft count direction.

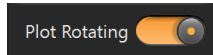

When 'Plot Rotating' is selected the graph rotates and the current position of the readhead remains at the top of the plot.

When 'Plot Rotating' is deselected the plot axes remain stationary with 90 degrees displayed at the top and the current position rotates around the graph.

NOTE: It is recommended that 'Plot Rotating' is disabled when using the rotary display at higher speeds.

6.6.4.4 Trigger selection

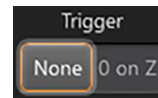

None	Default trigger mode. The plot starts automatically when the signal strength vs position screen is selected or the green arrow is pressed (section 6.6.4.1).
0 on Z	Zeroes the position of the trace relative to the reference mark. The plot starts automatically when the signal strength vs position screen is selected or the green arrow is pressed (section 6.6.4.1). When the reference mark is passed the 'Position (mm)' will be set to 0.

NOTE: When the trigger is changed, any previous data will be cleared.

6.7 Velocity plot



The velocity screen plots the readhead velocity against time.

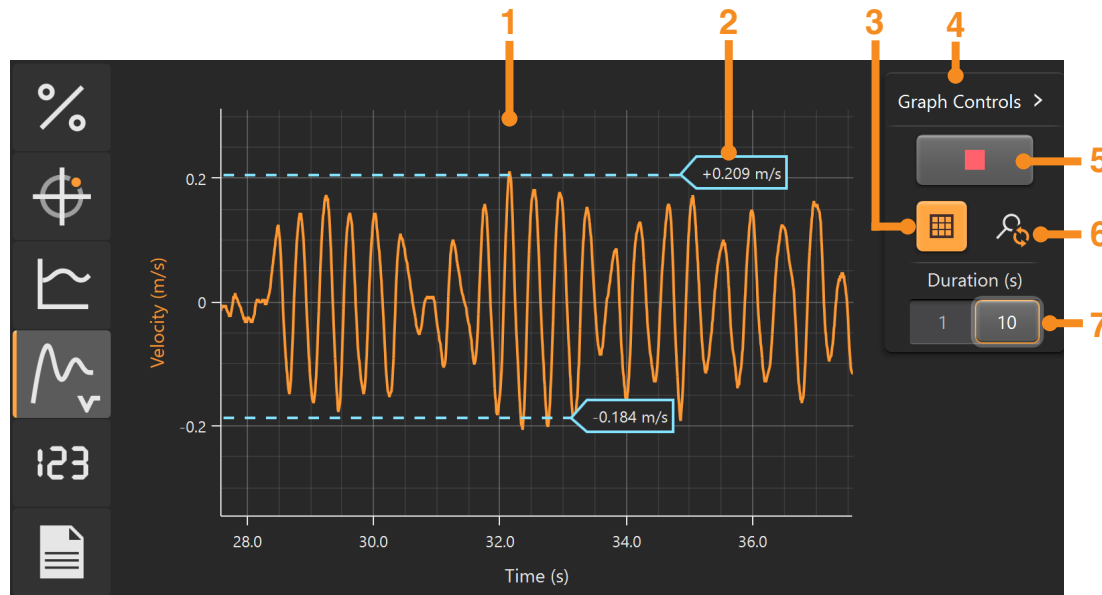

1. Plot of the readhead velocity against time

NOTE: The plot can be zoomed and panned. See section 6.6.4.2 for more information.

2. Cursors to measure peak velocity (section 6.7.1.3)
3. Enable/disable grid lines
4. Select to show/hide Graph Controls
5. Start/stop a plot (section 6.7.1.1)
6. Reset zoom
7. Select the X-axis scale and rate of data sampling

When an alarm or warning occurs, a pop-up describing the error condition will be displayed. See section 6.4.6 for more information on alarms and warnings.

NOTE: The velocity plot is only valid at speeds up to 5 m/s. At faster speeds the speed of movements may be faster than the data plot rate. At slow speed, the velocity plot may not be accurate due to quantisation in the encoder speed measurement.

6.7.1 Graph controls

6.7.1.1 Starting/stopping a plot

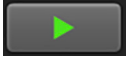

Click the green arrow to start a plot; the plot will automatically rescale as the readhead is moved along/around the axis. The arrow will change to a red square whilst data is being recorded. To stop the plot, click on the red square.

NOTE: Changing screens will clear the data and a new plot will restart automatically when the velocity screen is reselected.

6.7.1.2 Zooming and panning the plot

The plot can be zoomed and panned using a mouse, trackpad, touchscreen or similar.

To pan using a mouse:

- Point the mouse at the trace, click and hold the right mouse button and drag the trace left, right, up or down.

To zoom using a mouse/trackpad:

- Click with the left mouse button then drag the mouse to draw a box around the section of interest

Or

- Move the mouse wheel to zoom the whole plot in or out.

To zoom and pan using a touchscreen device:

- Pan by swiping finger along the screen in the direction you want to move the plot.
- Zoom using a thumb and finger. Move them away from each other to zoom in and 'pinch' them together to zoom out.

NOTES:

- When zooming or panning during a 'live' plot the data will continue to be plotted but only the selected area will be displayed and the plot will no longer scroll. To display the whole plot, select 'Reset zoom'.
 - Changing screens during data plotting will clear the data and a new plot will restart automatically when the signal velocity screen is reselected. Stop the plot before switching screens to retain the data.
-

6.7.1.3 Moving the cursors

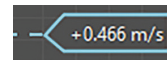

Click the cursors with the left mouse button and drag them to the chosen position to measure the velocity.

6.8 Digital readout (DRO)



This screen displays a linear or rotary digital readout (DRO) of the encoder position. The software will, where possible, automatically detect the readhead type connected and display a linear or rotary DRO accordingly. When the readhead type cannot be automatically detected the display will default to linear selection. See section 6.3 for details of linear and rotary selection.

NOTE: The DRO count may not agree exactly with the count registered by the controller. The DRO counter is based on calculated position rather than actual count.

6.8.1 Linear system

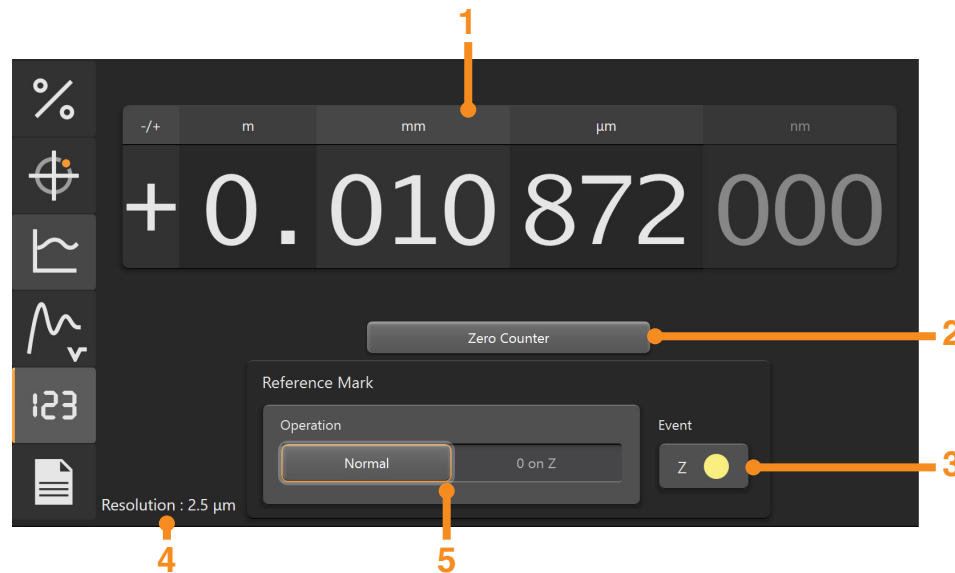

1. Digital readout of the encoder position
 2. Zero counter (section 6.8.3)
 3. Indication of reference mark location (section 6.8.3)
 4. Resolution of readhead
- NOTE:** For the analogue variant of QUANTiC the resolution will be interpolated and displayed as 1 μm .
5. Reference mark operation selection (section 6.8.3)

When an alarm or warning occurs, a pop-up describing the error condition will be displayed. See section 6.4.6 for more information on alarms and warnings.

The DRO will display the position in metres (m), millimetres (mm), microns (μm) and nanometres (nm). The digits displayed depends upon the resolution of the connected readhead, for example if a 1 μm head is connected then the 'nm' section of the display will be all zeros.

6.8.2 Rotary system



1. Digital readout of the encoder position
2. Zero counter (section 6.8.3)
3. Selection of ring/disc (section 6.3)
4. Resolution of readhead

NOTE: For the analogue variant of QUANTiC the resolution will be interpolated and displayed as 1 μm.

5. Reference mark operation selection (section 6.8.3)

When an alarm or warning occurs, a pop-up describing the error condition will be displayed. See section 6.4.6 for more information on alarms and warnings.

6.8.3 DRO controls

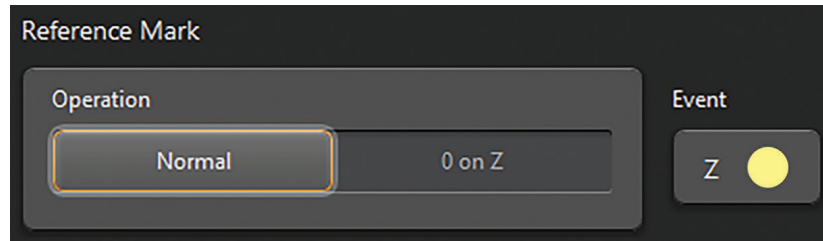

The DRO will automatically count when the DRO is selected. To zero the count as the readhead passes a reference mark select '0 on Z'.

When the readhead passes a reference mark the Z indicator will flash yellow indicating a reference mark has been detected.

NOTE: The event only indicates the presence of a reference mark. It does not display the phasing. For reference mark phasing refer to the Signal screen (section 6.4.2).

In 'Normal' operation the display can be zeroed by pressing the **Zero Counter** button.

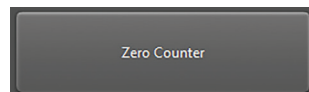

6.9 Configuration screen



The configuration screen provides information about the readhead and ADT connected, and allows factory default calibration values to be restored in the readhead (section 6.9.1).

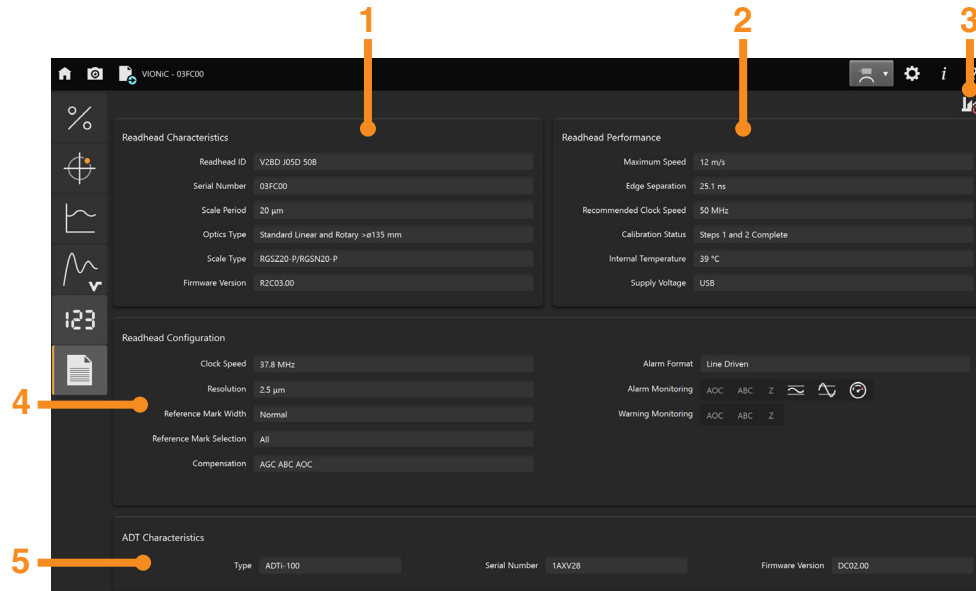

1. Readhead characteristics

- Read from the part number stored in the readhead

2. Readhead performance

- Theoretical maximum speed, minimum edge separation (based on a 1 m cable) and recommended clock speed based on the part number stored in the readhead
- Calibration status of the readhead
- Temperature of the microcontroller in the readhead (Temperature is not displayed when the readhead is in 'Calibration Mode')
- Supply voltage at the 'Encoder Output' of the ADT. If the ADT is used in-line, the voltage at the encoder output connector will be displayed.

3. Restore factory defaults (section 6.9.1)

4. Readhead configuration

- Read from the part number stored in the readhead
- Readhead internal clock frequency (Digital readheads only)
- The alarms and warnings that are enabled in the readhead are highlighted

5. ADT characteristics

NOTE: On smaller window sizes the configuration information will be displayed in tabs.

6.9.1 Restore factory defaults



When reinstalling the system, or in the case of calibration failure, factory defaults should be restored. To restore factory defaults, click on the factory symbol and follow the instructions on the screen.

The readhead will enter installation mode (section [6.4.3](#)).

Once factory defaults have been restored repeat the readhead set-up and calibration procedure (section [6.4.5](#)) as detailed in the relevant installation guide.

7. Troubleshooting

7.1 Software installation

Fault	Possible cause	Possible solutions
'Unspecified error' occurs during installation	.NET framework is not up to date	Install the latest .NET framework from https://www.microsoft.com/net/download

7.2 System connection

Fault	Possible cause	Possible solutions
ADT is connected but selection screen is not displayed	-	Check appropriate adaptor cables for the system
Readhead connected but not displayed on selection screen	-	Check appropriate adaptor cables for the system
ADT does not connect to software	Windows® has not detected the ADT	Disconnect and reconnect the USB cable
ADT disconnects from the software when the PC goes into power saving (sleep) mode	Power-save mode disconnects all USB devices	<ul style="list-style-type: none"> Switch power save mode off on the PC Disconnect and reconnect the USB cable

7.3 General

Fault	Possible cause	Possible solutions
Text is not displayed correctly	Changing the size of text and resolution in 'Display' can affect the quality of the display	Restore PC to default Windows® theme
Unable to switch AGC on	Readhead is in installation mode or calibration mode. AGC is disabled in these modes.	Check readhead is in normal running mode (section 6.4.3)
Limit indication not displayed on the software	Readhead does not have limit outputs	Check connected readhead has limit outputs

7.4 Calibration

Fault	Possible cause	Possible solutions
Readhead appears to jump from 'installation' mode to 'normal' mode without going through calibration	Readhead is actually in overspeed or low/high signal alarm condition in 'Normal' mode (4 red flashes) NOTE: Installation mode (constant red flashing)	<ul style="list-style-type: none"> • Check readhead is in Installation mode and not in alarm. 'Installation mode' is displayed at the bottom of the screen (section 6.4.3). • Low/high signal: Clean scale and/or re-align readhead and recalibrate system (section 6.4.5) • Overspeed: Reduce operating speed to be within the specified specification
Cannot exit Calibration mode	Incremental signal calibration is not complete	<ul style="list-style-type: none"> • Complete incremental signal calibration (section 6.4.5) • Restore factory default and repeat calibration routine • Analogue variant of QUANTiC only - Ensure correct termination is fitted to the output of the ADT (section 2.2)
Unit entered Calibration mode as soon as readhead was connected to ADT	The readhead was powered up when in low signal alarm	<ul style="list-style-type: none"> • Ensure readhead is not in low signal alarm when powered up • Disconnect power to the ADT before connecting the readhead • Analogue variant of QUANTiC only - Ensure correct termination is fitted to the output of the ADT (section 2.2)

7.5 Signal screen

Fault	Possible cause	Possible solutions
The phasing of the reference mark on the signal screen keeps changing	The reference mark is not phased until the readhead has been calibrated	Calibrate readhead (section 6.4.5)
	Readheads with all reference marks selected will display all reference marks on the software but only the calibrated reference mark is guaranteed to remain phased	Ensure the calibration sequence is carried out on the required reference mark
Pitch indication is not displayed	Readhead connected does not display pitch	-
Signal size is fluctuating from high signal to low signal (analogue variant of QUANTiC only)	Incorrect termination	Ensure correct termination is fitted to the output of the ADT (section 2.2)
The signal size is low but no alarm is displayed	A pop-up appears on all screens for 3 seconds when an alarm or warning occurs but the current alarms and warnings are only permanently shown on the signal strength vs position screen (section 6.4.6)	Display signal strength vs position screen to see current alarms and warnings

7.6 Signal strength vs position screen

Fault	Possible cause	Possible solutions
Rotary readhead connected but plot displayed is linear	The ADT cannot determine if the readhead is linear or rotary, the default display is linear	Select rotary scale from the linear/rotary menu (section 6.3)
The plot is running but there are no units displayed on the position axis (linear ADTi-100 only)	0 on Z trigger mode is selected and a reference mark has not been passed. The X axis units are not displayed until a reference mark is passed. The current position will then be set to zero.	Move the readhead past a reference mark or change the trigger to 'None'
The position is moving but the plot is not being displayed (rotary ADTi-100 only)	0 on Z trigger mode is selected but a reference mark has not been passed. The plot is not displayed until a reference mark is passed. The plot will then start and the current position will be set to zero. NOTE: The limits will not be displayed until the readhead has passed the reference mark	Move the readhead past a reference mark or change the trigger to 'None'
The reference mark position moves position	The reference mark is not phased until the readhead has been calibrated	Calibrate readhead (section 6.4.5)
Multiple reference marks are displayed	The readhead has all reference mark outputs enabled so a reference mark is output at every reference mark on the scale	Order a readhead with customer selectable reference marks
	Readhead is pitched well in excess of the system tolerances NOTE: Pitch indicator may not show a pitch misalignment for grossly pitched readheads	Realign readhead and recalibrate system
The plot is still running but is not visible/changing	When zooming or panning during 'live' plot the data is still being captured but only the selected area will be displayed	Reset zoom (section 6.6.1) or stop the plot (section 6.6.4.1) to display the complete trace
The plot has stopped	The signal strength vs position plot stops when the signal strength is too low for reliable data to be plotted (ADTi-100 only)	<ul style="list-style-type: none"> • Check signal size • Press the green arrow to restart the plot NOTE: Ensure screen is saved before restarting plot (section 6.6.4.1) as all plot data will be lost

7.7 Velocity screen

Fault	Possible cause	Possible solutions
The plot is still running but is not changing	When zooming or panning during 'live' plot the data is still being captured but only the selected area will be displayed	Reset zoom (section 6.7) or stop the plot (section 6.7.1.1) to display the complete trace

7.8 DRO screen



Fault	Possible cause	Possible solutions
The DRO display is not counting and displays dashes	No ring diameter has been selected	Select ring diameter (section 6.8.2)

7.9 Configuration screen

Fault	Possible cause	Possible solutions
The readhead characteristics and configuration sections are empty	For custom readheads this information may not be decoded from the readhead	Contact Renishaw with the serial number of the unit for more information on the configuration

www.renishaw.com/contact

 #renishaw

 +44 (0) 1453 524524  uk@renishaw.com

© 2016–2022 Renishaw plc. All rights reserved. This document may not be copied or reproduced in whole or in part, or transferred to any other media or language by any means, without the prior written permission of Renishaw.
RENISHAW® and the probe symbol are registered trade marks of Renishaw plc. Renishaw product names, designations and the mark 'apply innovation' are trade marks of Renishaw plc or its subsidiaries. Other brand, product or company names are trade marks of their respective owners. Renishaw plc. Registered in England and Wales. Company no: 1106260. Registered office: New Mills, Wotton-under-Edge, Glos, GL12 8JR, UK.

WHILE CONSIDERABLE EFFORT WAS MADE TO VERIFY THE ACCURACY OF THIS DOCUMENT AT PUBLICATION, ALL WARRANTIES, CONDITIONS, REPRESENTATIONS AND LIABILITY, HOWSOEVER ARISING, ARE EXCLUDED TO THE EXTENT PERMITTED BY LAW. RENISHAW RESERVES THE RIGHT TO MAKE CHANGES TO THIS DOCUMENT AND TO THE EQUIPMENT, AND/OR SOFTWARE AND THE SPECIFICATION DESCRIBED HEREIN WITHOUT OBLIGATION TO PROVIDE NOTICE OF SUCH CHANGES.

Part no.: M-6195-9413-07-A
Issued: 09.2022